

Deckenloch bei  
Deckenstärke ca 250 mm  
630 x1750 mm

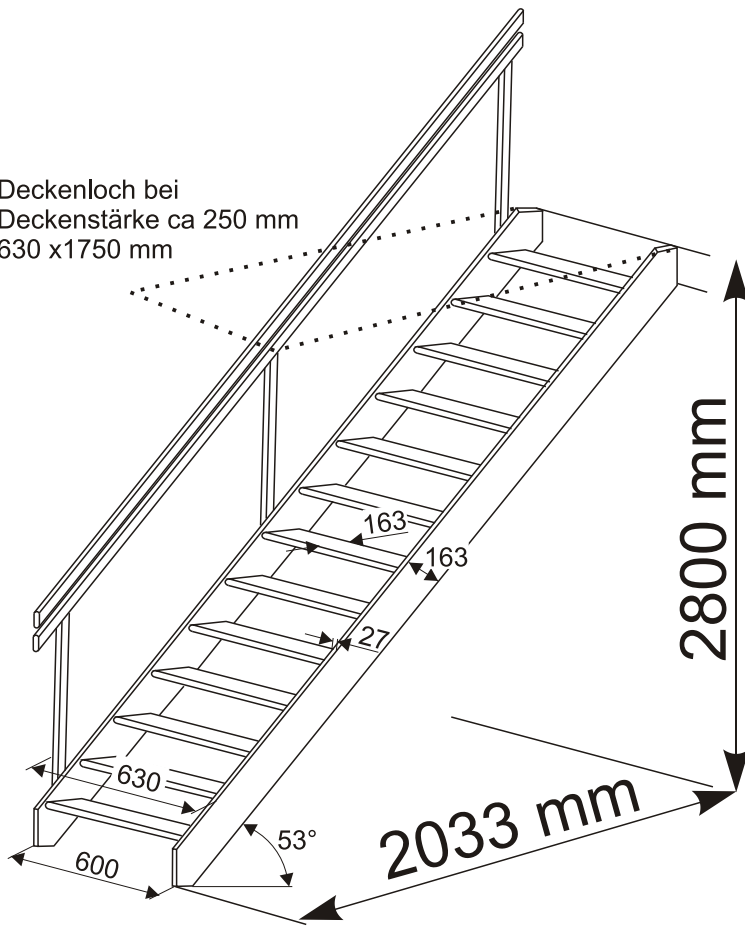

# BORAS

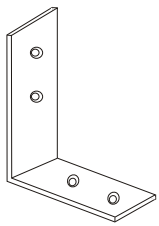
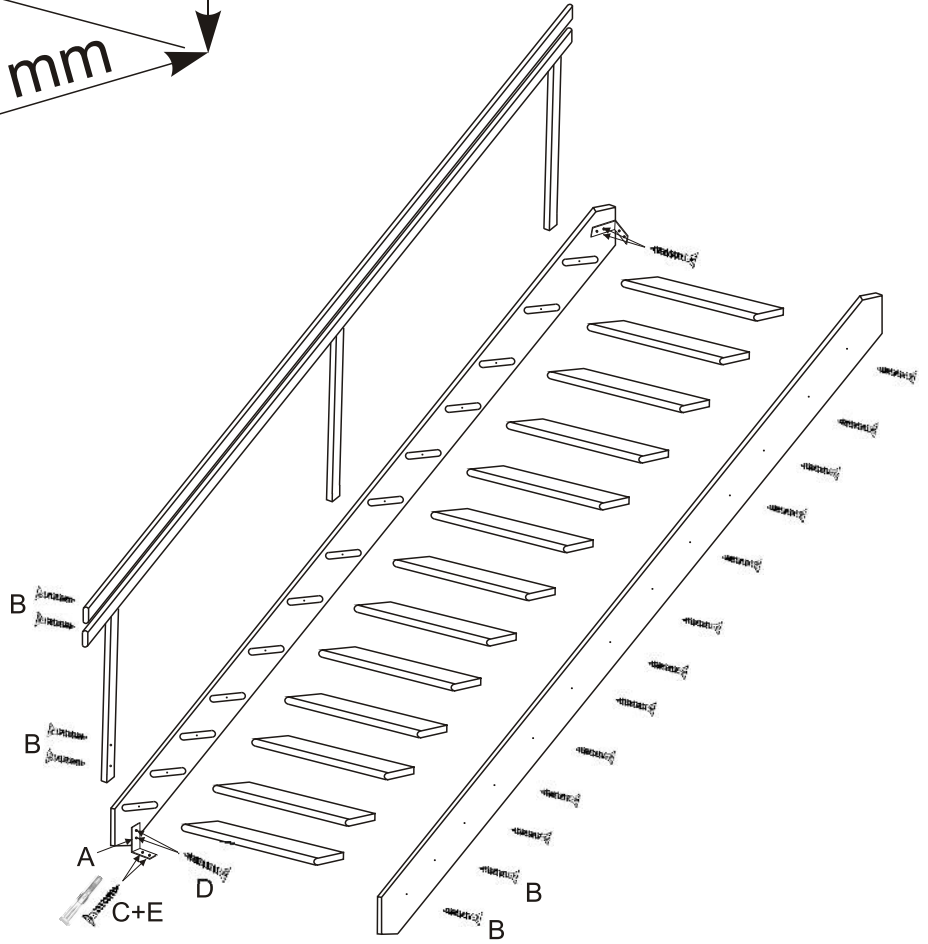

A 4 Stk



B 38 Stk  
Spax 5 x 40



C 8 Stk  
Spax 4,5 x 50



D 8 Stk  
Spax 4,5 x 25



E 8 Stk  
Dübel S8

