

8	9	10	11	12	13
1376	1548	1720	1892	2064	2236
-	-	-	-	-	-
1872	2106	2340	2574	2808	3000

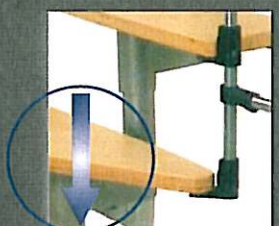

⊖ 172-233 mm

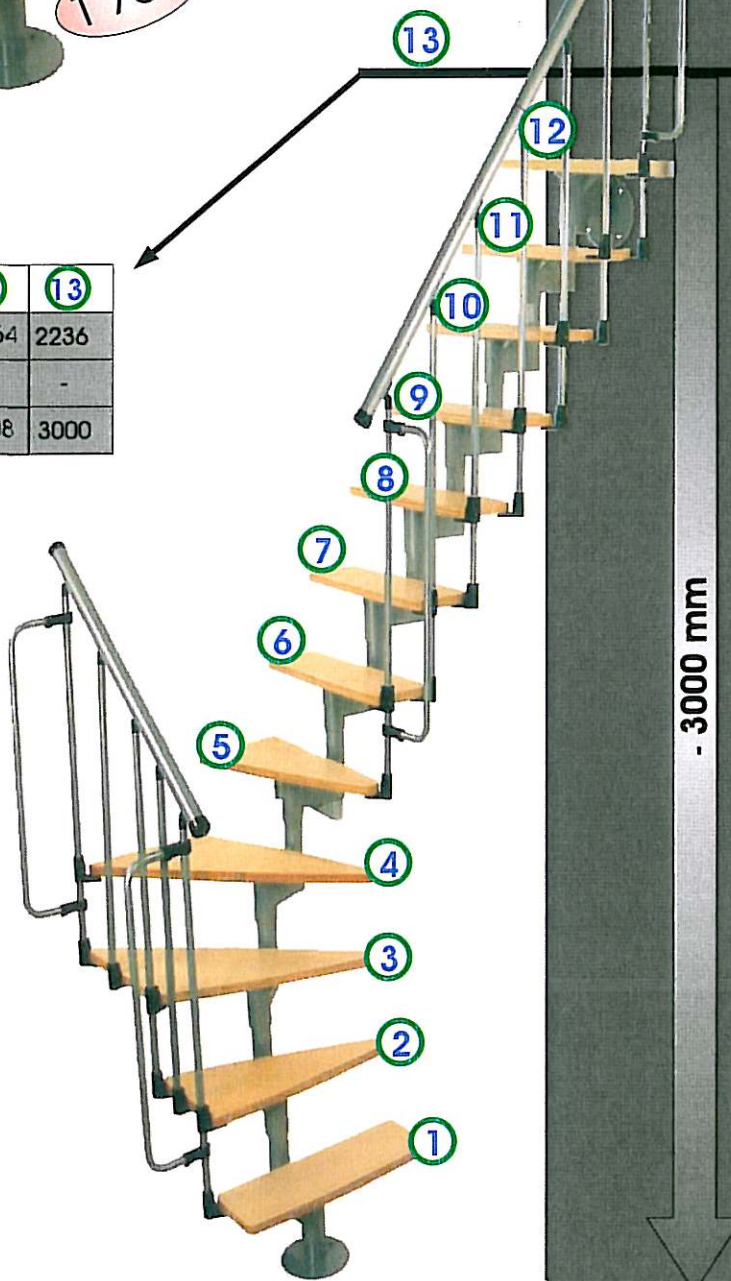
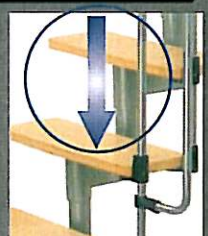

⊖ 200 kg 

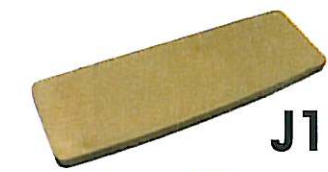

J1

12 x - 930034

12 x - 932053

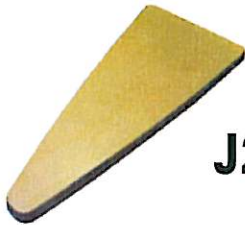

J2

2 x - 932035

2 x - 932054



J3

2 x - 932036

2 x - 932055



J4

11 x - 921012



J5

1 x - 921013



J6

1 x - 920487



J7

1 x - 920485

Ø 22 x 995mm

J8

17 x - 932039



J9

4 x - 932037



J10

1 x - 921006

1 x - 921008



J11

1 x - 921007



J12

M8 x 1000 mm

3 x - 930706



J13

Ø50 x 952 mm

3 x - 932038

3 x - 931261



J14

Ø22 mm

17 x - 930631



J15

Ø35 mm

4 x - 932138



J16

Ø60 mm

11 x - 930851



J17

17 x - 932031



J18

34 x - 932032



J19

17 x - 913217



J20

5 x - 932137



J21

8 x - 930623

M10 x 70mm DIN 933



2 x - 931060

M8 x 70mm DIN933



15 x - 931735

M8 x 55mm DIN933



2 x - 930656

M5 x 20mm DIN7991



17 x - 930676

M10 x 8mm DIN914



24 x - 931062

M6 x 6mm DIN914



50 x - 930632

Ø5 x 30mm



102 x - 930200

Ø5 x 25mm



72 x - 931063

Ø3,9 x 16mm DIN7504P



34 x - 931221

M8 x 55mm



15 x - 931733

M6 DIN562



50 x - 930633

M5 DIN934



17 x - 930727

M8 DIN934



6 x - 930233

M8 DIN6334



2 x - 930679

M10 DIN1587



2 x - 931879

Ø 30mm M10 DIN9021A



8 x - 930600

Ø16mm M8 DIN125A



19 x - 931078

Ø19mm M10 DIN125A



2 x - 931061

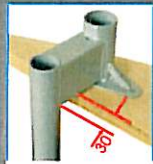
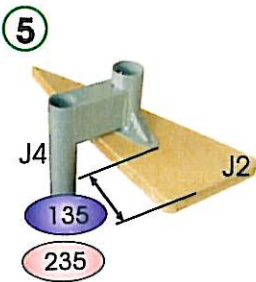
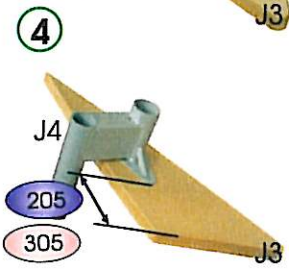
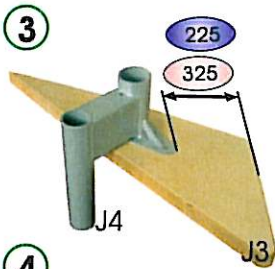
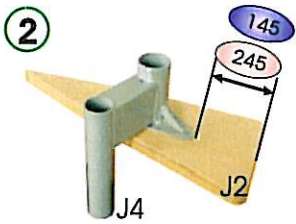
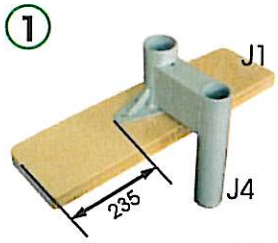

② 30 mm



③ 6 x J29

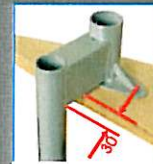
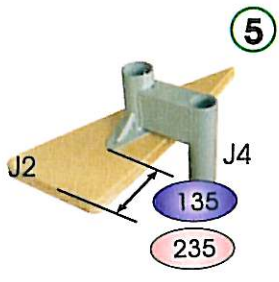
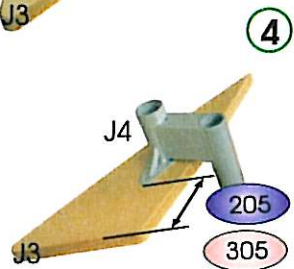
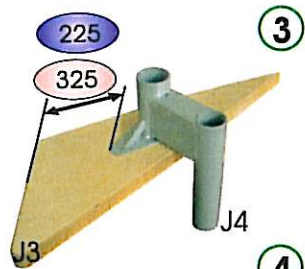
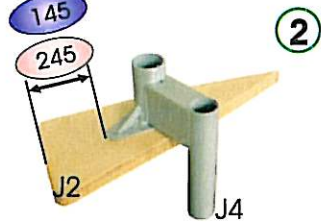
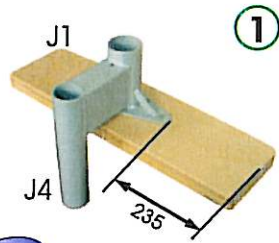

② 30 mm



③ 6 x J29

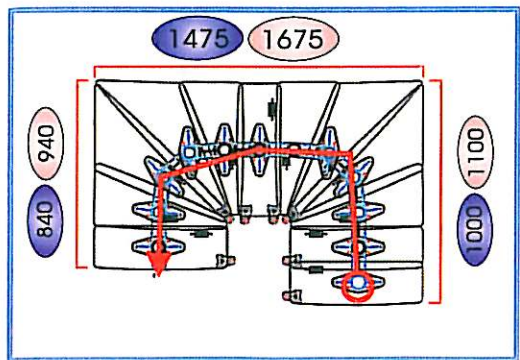
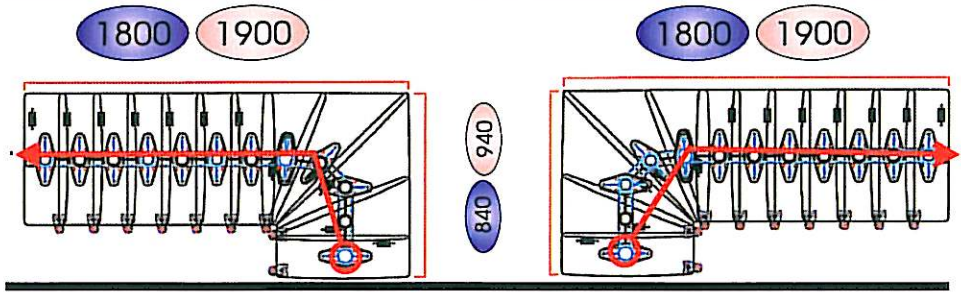
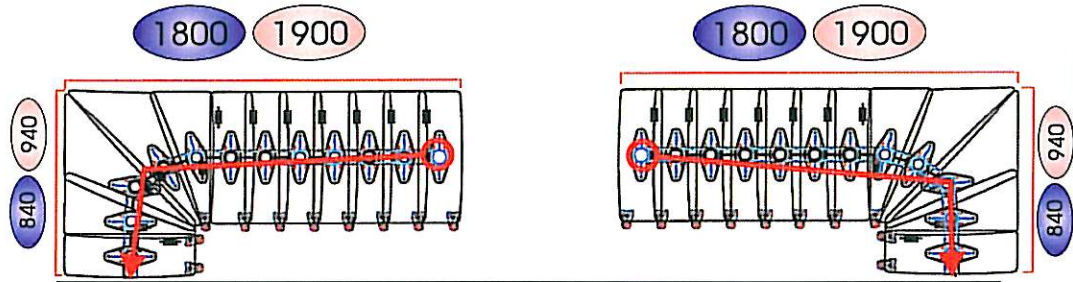
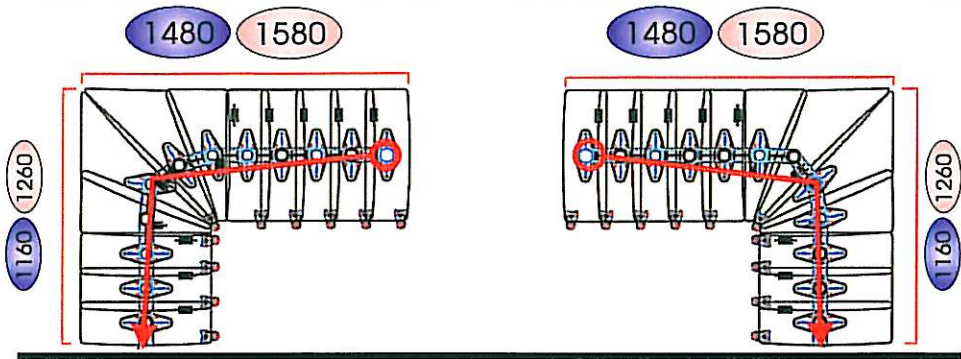
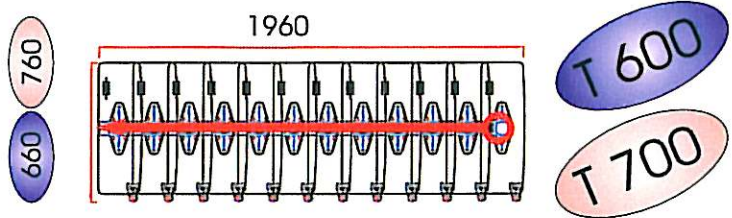

1

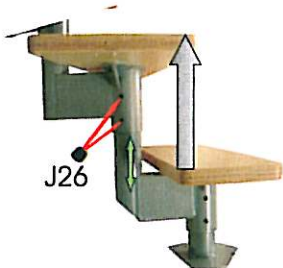

4 172 - 233 mm

5 2 x J26



6 J26

7 $\varnothing 12$ mm

8 13

9 0° / 180°

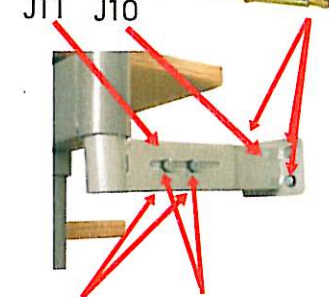
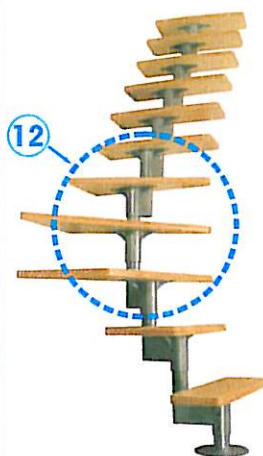
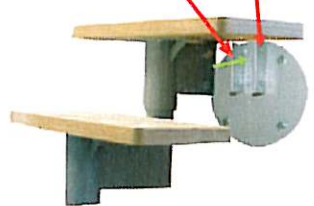
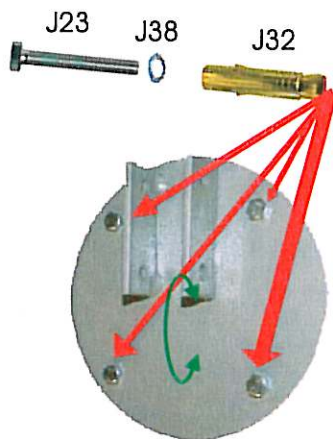

10 17

11 -

12 $\varnothing 12$ mm

13 13

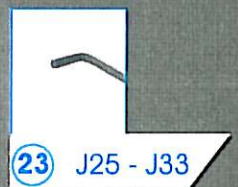
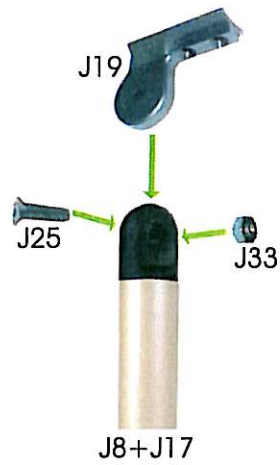
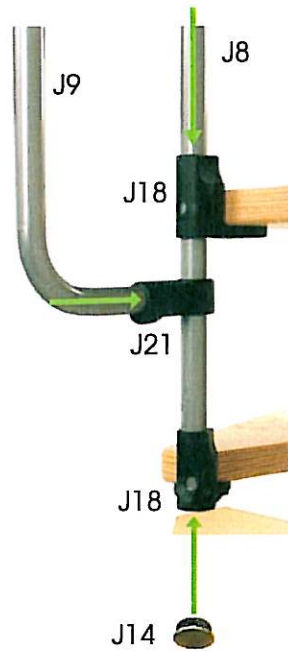
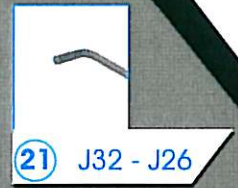
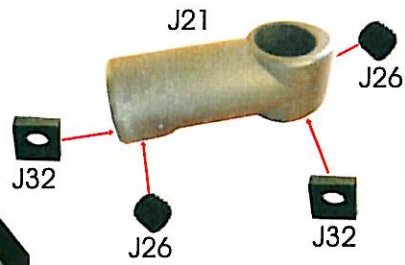
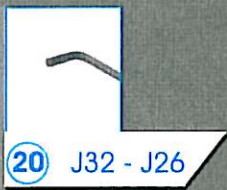
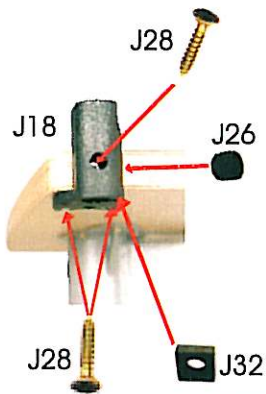
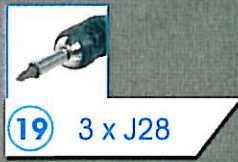
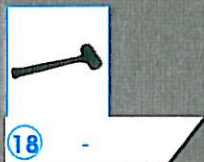
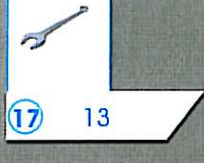
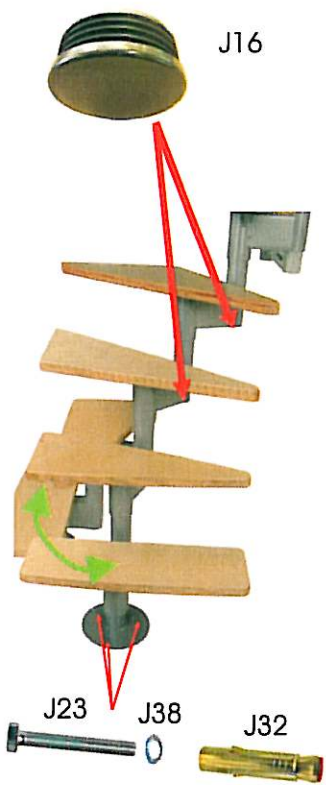

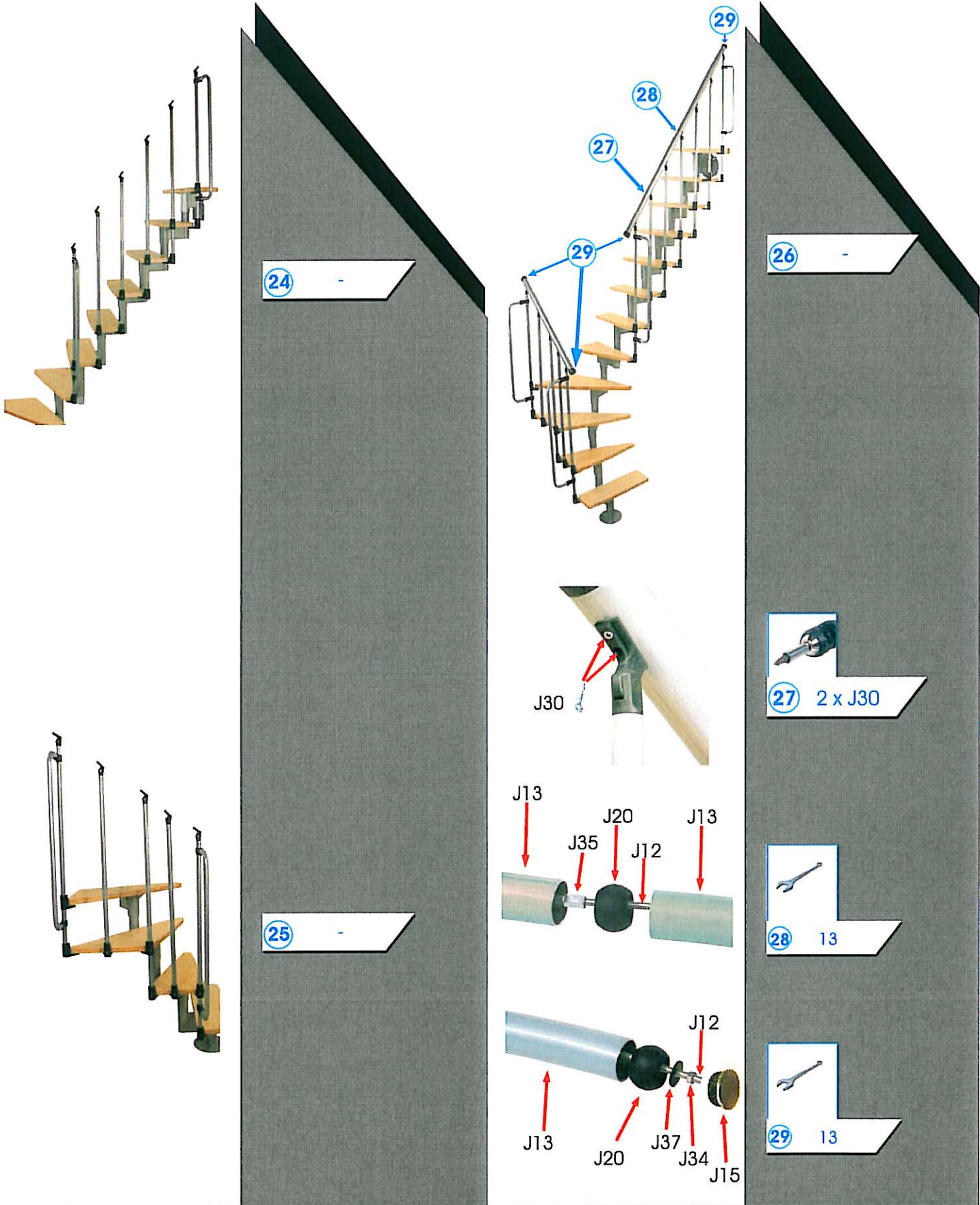

1000 mm



ø50 x 980mm

W1

1 Stk - 932147

1 Stk - 932148



ø22 x 45 mm

W2

1 Stk - 932121

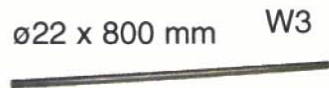

ø22 x 800 mm

W3

8 Stk - 932146



M8x1000 mm

W4

1 Stk - 930706



W5

8 Stk - 931222



W6

8 Stk - 932031



W7

2 Stk - 930623



W8

8 Stk - 931217



W9

2 Stk - 932137



ø12 mm

W10

8 Stk - 930687



ø35 mm

W11

2 Stk - 932138

M8 DIN 934



W12

2 Stk - 930233

M5 DIN 934



W13

8 Stk - 930727

M8 DIN 6334



W14

1 Stk - 930679

M6 DIN 562



W15

12 Stk - 930633



M8 x 80 mm

W16

1 Stk - 932144

ø8 x 60mm DIN 571



W17

8 Stk - 930599

M5 x 20mm DIN 7991



W18

8 Stk - 930676

M6 x 6mm DIN 914



W19

12 Stk - 930632

ø3,9 x 16mm DIN 7504P



W20

16 Stk - 931221

ø30 mm M10 DIN 9021A



W21

2 Stk - 930600

ø16 mm M8 DIN 125A



W22

10 Stk - 930680

