

GAMIA METAL

MONTAGEANLEITUNG

Italiano

Descrizione

Scala chiocciola modulare in metallo a pianta circolare regolabile in altezza tramite distanziatori metallici interposti tra i gradini.

Nr. gradini e altezze raggiungibili per scale "filo-pavimento"

11 + 1 gradini : 2520 - 2760 mm

12 + 1 gradini : 2730 - 2990 mm

13 + 1 gradini : 2940 - 3220 mm

Gradini

Di lamiera stampata, con striscia adesive antisdrucchiolo

Alzate

Standard Min. 210 mm; Max 230 mm (per alzate 200 ÷ 210 mm; 230 ÷ 240 mm si possono adattare le colonne in fase di posa).

Ringhiera

A colonne in tubo di metallo Ø 22 mm (luce max tra le colonne < 100 mm). Corrimano di materiale plastico flessibile (ht. corrimano = 1 m).

Finitura e colori

Parti di metallo: verniciate a forno con polveri epossidiche.

Componenti in plastica, gomma e viteria: nero.

Kit

- a) Confezione nr. 11 gradini semplici completi Ø 1200, 1400, 1600 mm
- b) Confezione pianerottolo di arrivo completo Ø 1250, 1450, 1650 mm
- c) Confezione gradino semplice aggiuntivo Ø 1200, 1400, 1600 mm
- d) Confezione balaustra 1 m
- e) Confezione "traversino/alzata" per nr.11 gradini

NOTE PER LA POSA

Prima di procedere con la posa:

- **verificare le dimensioni del vano scala;**
- **controllare che, nelle zone dove verranno effettuati i fissaggi della scala, non vi siano tubature o cavi elettrici, onde evitarne il danneggiamento;**
- **verificare la capacità di carico del pavimento**

1) Assemblare il palo nella sequenza indicata bloccando saldamente gli elementi fra loro, facendo leva con un perno negli appositi fori dei tubi.

2) Posizionare il palo in riferimento al foro, disponendo il gradino di arrivo sul lato di uscita della scala. Verificare l'esatta perpendicolarità al pavimento. Prima di bloccare lo sbarco, assicurarsi della sua perfetta orizzontalità utilizzando una livella. Prima di segnare la posizione dei fori della piastra del palo centrale sul pavimento, bloccare temporaneamente il gradino di sbarco per evitare spostamenti ed errori di misurazione. In caso di pavimenti/travi in legno utilizzare solo mordenti/viti da legno per sostituire quelle fornite, adatte solo per cemento armato.

- 3)** Regolare i distanziali in plastica avvitando la ghiera filettata, lasciando tra le due battute una distanza pari a "Alzata - 170 mm". E' poi necessario aumentare l'altezza con mezzo giro in meno sul distanziale al fine di recuperare la compressione sul filetto della vite (tolleranza) in fase di serraggio di tutti i gradini. N.B. Per la 1° alzata occorre tenere conto della piastra del palo centrale e dell'interferenza dovuta alla saldatura piastra – palo.
- 4)** Inserire gli elementi nel palo iniziando dal copripiastra in basso, proseguendo con distanziali e gradini, sino all'inserimento del gradino di arrivo.
- 5)** Posizionare il pianerottolo di arrivo in funzione della forma del foro. In caso di pavimenti/travi in legno utilizzare solo mordenti/viti da legno per sostituire quelle fornite, adatte solo per cemento armato.
- 6)** Inserire nel palo la flangia terminale, la barra filettata ed il terminale, quindi avvitare con il dado, in modo da comprimere la scala, ma lasciando ai gradini la libertà di ruotare.
- 7)** Comporre il raccordo "Novia" assemblando gli elementi. Per l'assemblaggio dei componenti in plastica utilizzare sempre del grasso lubrificante.
- 8)** Inserire le colonne in tutti i gradini, bloccando quelle passanti con i grani e quelle sul gradino con la boccola ad espansione "Espa". Bloccare bene l'inserito in plastica nella boccola di plastica prima di inserirlo nelle colonnine. Non avvitare troppo a fondo il grano perché potrebbe danneggiare la colonna durante il suo inserimento nel foro. Non serrare completamente i grani delle colonne passanti prima di aver terminato il serraggio della scala completa. Completare il serraggio solo dopo aver avvitato completamente la barra filettata M22 con il dado.
- 9)** La prima colonna della scala va tagliata e fissata a terra tramite il "Bicchierino". In caso di pavimenti/travi in legno utilizzare solo mordenti/viti da legno per sostituire quelle fornite, adatte solo per cemento armato.

10) Regolazione colonne

Prima di bloccare le colonne eseguire la regolazione della pendenza in funzione dell'alzata.

11) Questo disegno mostra il kit "traversino/alzata" montato sul mod. GAMIA LEGNO. Per la scala GAMIA METALLO le istruzioni di montaggio sono le medesime. Se la colonnina del para alzata è troppo lunga, è necessario tagliarla a misura.

12) Completato il montaggio della scala, applicare su tutti i gradini le strisce adesive antisdrucchiolo

13) Montaggio balaustrino del gradino di arrivo

Disporre le colonne sul gradino di sbarco e inserirvi le cime: in corrispondenza del foro passante utilizzare una colonna da 1165 mm da tagliare a misura.

Fissare la colonna stop fornita per bloccare l'ultima colonna passante sul pianerottolo di sbarco (lato opposto al balaustrino) o l'ultima colonna del balaustrino.

Assemblare i corrimani alle colonne, fissando le cime con le apposite viti. Il corrimano va fissato prima sulle colonne passanti e poi su quelle centrali al gradino.

14) Montaggio Balaustra

-Assemblare le colonne (ht. 925 mm) inserendo la boccola "Espa" ed avvitando il mordente.

-Tracciare sul pavimento il centro delle colonne mantenendo la distanza dal foro di circa 50 mm (l'interasse tra le colonne non deve superare i 120 mm).

- Forare con punta \varnothing 12 mm ed inserire gli espansori in nylon.

- In caso di pavimenti/travi in legno utilizzare solo mordenti/viti da legno per sostituire quelle fornite, adatte solo per cemento armato.

English

Description

Modular spiral staircase in metal, with round section and adjustable spacers

Number of steps and “floor-to-floor” height

11 + 1 steps : 2520-2760 mm (8 3 1/4" - 9 0")

12 + 1 steps : 2730-2990 mm (8 11 1/2" - 9 9 3/4")

13 + 1 steps : 2940-3220 mm (9 7 3/4" - 10 6 3/4")

Steps

Of stamped plate, with adhesive non-slippery strips

Risers

Standard Min 210 mm (8 1/4"); Max 230 mm (9") (for risers 200 ÷ 210 mm (7 7/8" ÷ 8 1/4"); 230 ÷ 240 mm (9" ÷ 9 1/2")) it is possible to cut the balusters during the assembly)

Railing

With metal steel tubing balusters Ø 22 mm (7/8") (clear space among the balusters < 100 mm, 4").
Flexible plastic handrail (handrail height = 1000 mm, 39 3/8")

Finishes and colours

Metal: plastic coated.

Plastic componentes, rubber matting and screws: black.

Kit

- a) Packing with 11 complete simple steps Ø 1200, 1400, 1600 mm (47 1/4", 55 1/8", 63")
- b) Packing with complete landing platform Ø 1250, 1450, 1650 mm (49 1/4", 57 1/8", 65")
- c) Packing with one simple extra step Ø 1200, 1400, 1600 mm (47 1/4", 55 1/8", 63")
- d) Packing balustrade 1000 mm (39 3/8") long section (handrail apart)
- e) Packing “safety-riser” for 11 steps

NOTES FOR INSTALLATION

Before starting to install the stair:

- check well all staircase well dimension;

-make sure that in the installation area there are no pipes or power cables to prevent damaging these;

- check the bearing capacity of the pavement.

1) Assemble the pole in the sequence indicated, locking the elements firmly together, levering using a pin in the holes in the tubes.

2) Position the post with reference to the opening, arranging the landing step on the exit side of the stair. Before securing the platform, make sure of its perfect horizontality by the use of the level tube. Before taking the measure of the holes in the floor for the center pole, block temporarily the platform on the pole to avoid traveling and measurement errors. In the case of wooden floor/slab use only screws for wood, of the hanger bolt/leg bolt type, to replace those provided exclusively suited to reinforced concrete.

3) Regulate the plastic spacers adjusting the ring nut, leaving between the two edges a distance equivalent to: Riser – 170 mm (6 11/16"). It is necessary to give a half turn more to the flange of all plastic spacers, so as to increase the average height and recover the tolerances of the threading when you compact the stair. Attention: in the first rise, from the average height of the plastic spacer must be deducted the thickness of the central pole plate.

- 4) Insert the elements in the post beginning from the plate cover, going on with spacers and steps and finishing with the landing.
- 5) Position the landing step according to the opening. In the case of wooden floor/slab use only screws for wood, of the hanger bolt/leg bolt type, to replace those provided exclusively suited to reinforced concrete.
- 6) Insert the terminal flange, the threaded bar and the terminal in the pole, then tighten using the nut, in order to compress the staircase, but leaving the steps free to rotate.
- 7) Put together the pipe fitting "Novia" assembling the elements. For the assembly of plastic components of the railing always use the lubricating grease.
- 8) Insert balusters in all steps, doweling the ones that go through the step and locking the other ones with the expansion bushing "Espa". Lock well the plastic insert in the outer bush of plastic, before inserting it in the baluster. be careful not to overtighten the screw. check it before inserting the column into the hole Do not fully tighten all the fixing dowels of the passing balusters before having compacted the whole stair. Finish the definitive tightening only after having completely screwed the threaded rod with a M22 nut.
- 9) The first baluster of the stair need to be cut and secured to the floor with pipe fitting "Bicchierino". In the case of wooden floor/slab use only screws for wood, of the hanger bolt/leg bolt type, to replace those provided exclusively suited to reinforced concrete.

10) Balusters ajustement

Before baluster's tightening it is necessary to adjust the slope according to the risers.

11) This draw shows the assembling of "Safety-riser" for model Gamia Wood. The same instructions are for model Gamia Metal. If the safety riser baluster is too long, you need to resize it to measure

12) Having completed the staircase assembly, apply the supplied adhesive non-slippery strips

13) Assembling of landing balustrade

For the platform railing, in correspondence of the passing hole use the baluster 1165 mm long that is specially provided in the kit, to be cut to size. Fix the provided baluster-floor fixing element to block the last passing baluster on the landing platform (on the opposite side of the platform railing) or the last baluster of the platform railing.

The handrail of the stair must be fixed first to the passing balusters and secondly to the central balusters of the step.

14) Balusters assembling

- Assemble the balusters (Ht. 925 mm, 36 3/8") connecting the bushing "Espa" and screwing the fitting
- Mark out the floor the central position of the balusters for the balustrade, note also that a distance of about 50 mm (2") from the opening is needed and that the axle base among the balusters can't be over 120 mm (4 1/2")
- Drill holes with a \varnothing 12 mm (1/2"94) bit and insert the nylon expanders.
- In the case of wooden floor/slab use only screws for wood, of the hanger bolt / leg bolt type, to replace those provided exclusively suited to reinforced concrete.

Français

Description

Escalier hélicoïdal modulaire en métal / bois à plan circulaire réglable en hauteur avec entretoises en métal entre les marches.

N. marches et hauteurs possibles au "niveau du sol"

11 + 1 marches : 2520 - 2760 mm

12 + 1 marches : 2730 - 2990 mm

13 + 1 marches : 2940 - 3220 mm

Marches

En tôle étampée, avec bandes adhésive antidérapantes

Hauteur de marche

Standard Min. 210 mm; Max 230 mm (pour hauteurs 200 ÷ 210 mm; 230 ÷ 240 mm balustres adaptables pendant la pose).

Rampe

Avec balustres en tube de métal Ø 22 mm (distance entre les balustres < 100 mm). Main courante en matériel plastique flexible (hauteur main courante = 1 m).

Finitions et couleurs

Parties en métal : traitées en époxy.

Parties en plastique, tapis et visserie: noir.

Kit

a) Carton n. 11 marches simples complètes Ø 1200, 1400, 1600 mm

b) Carton palier d'arrivée complet Ø 1250, 1450, 1650 mm

c) Carton marche simple supplémentaire Ø 1200, 1400, 1600 mm

d) Carton garde-corps 1 m

e) Carton " bras / hauteur de marche " pour n. 11 marches

Vérifier les dimensions de la cage avant de procéder à la pose.

Vérifier que les fixations de l'escalier ne tombent pas sur des conduites ou des câbles électriques

1) Assembler le poteau.

2) Positionner le poteau dans l'axe exact de la trémie, en plaçant la marche d'arrivée sur le côté de sortie de l'escalier.

3) Régler les entretoises en plastique en serrant la bague fileté et en gardant une distance égale à "Hauteur de marche - 170 mm".

4) Empiler tour à tour les éléments (entretoises et marches) dans le poteau sans oublier au départ le couvrebase et terminer avec l'installation de la marche d'arrivée.

5) Positionner la marche d'arrivée.

6) Insérer dans le poteau le bride terminal.

7) Assembler le raccord "Novia" en montant les éléments.

8) Insérer les balustres dans toutes les marches en bloquant ceux du type passant avec les vis et ceux sur

la marche avec l'expansion "Espa".

9) Découper et fixer au sol le premier balustre avec le gobelet "Bicchierino".

10) Réglage des balustres

Avant de bloquer les balustres, régler les en fonction de la pente créée par la hauteur de marche.

11) Ce dessin montre le kit bras/hauteur de marche assemblé sur le modèle GAMIA BOIS. Pour l'escalier GAMIA METAL les instructions de montage sont les mêmes.

12) Une fois le montage de l'escalier terminé, appliquer sur toutes les marches bandes adhésives antidérapantes

13) Montage de la rampe du palier d'arrivée

14) Montage du garde-corps

-Assembler les balustres du garde-corps (h. 925 mm) en insérant la pièce "Espa" et en serrant le mordant.

-Tracer au sol l'axe des balustres du garde corps en gardant une distance par rapport au bord de la trémie d'environ 50 mm (L'entraxe entre les balustres ne doit pas excéder les 120 mm).

- Percer avec un foret Ø 12 mm et insérer les chevilles à expansion en nylon.

Espanol

Descripción

Escalera de caracol modular de metal / madera con planta circular con altura regulable mediante los distanciadores de metal entre los peldaños.

Nº Peldaños y alturas totales posibles a "nivel del piso"

11 + 1 peldaños : 2520 - 2760 mm

12 + 1 peldaños : 2730 - 2990 mm

13 + 1 peldaños : 2940 - 3220 mm

Peldaños

De chapa estampada, bandas adhesivas antideslizantes

Contraheullas

Estándar MÍN. 210 mm; Max 230 mm (para contraheullas 200 ÷ 210 mm; 230 ÷ 240 mm los barrotes se pueden adaptar en fase de montaje).

Baranda

De barrotes en tubo de metal Ø 22 mm (luz entre los barrotes < 100 mm). Pasamanos de material plástico flexible (altura pasamanos = 1 m).

Acabado y colores

Piezas de metal : barnizadas al horno con polvos epoxídicos (Negro gofrado).

Elementos de plástico, goma y tornillos: negros.

Kit

- a) Confección 11 peldaños simples Ø 1200, 1400, 1600 mm
- b) Confección rellano de desembarque completo Ø 1250, 1450, 1650 mm
- c) Confección peldaño simple extra Ø 1200, 1400, 1600 mm
- d) Confección balaustera 1 m
- e) Confección "barra/contraheulla" para 11 peldaños

Verificar las dimensiones del espacio donde irá la escalera antes de iniciar el montaje Controlar que, en las zonas donde se efectuarán las fijaciones de la escalera, no haya tubos o cables eléctricos, para evitar daños.

- 1) Montar el eje.
- 2) Colocar el eje con referencia al orificio, poniendo el rellano de desembarque sobre el lado de salida de la escalera.
- 3) Regular los distanciadores de plástico enroscando la virola roscada, dejando entre los dos topes una distancia equivalente a "Contraheulla - 170 mm".
- 4) Insertar los elementos en el eje comenzando por la brida del eje, continuando con los distanciadores y los peldaños, hasta insertar el rellano de desembarque.
- 5) Fijar el rellano de desembarque
- 6) Insertar en el eje la brida terminal.
- 7) Componer el acoplamiento "Novia" montando los elementos.

8) Insertar los barrotes en todos los peldaños, bloqueando aquellos pasantes con los tornillos sin cabeza y aquellos sobre el peldaño con el casquillo de expansión "Espa".

9) El primer barrote de la escalera se corta y se fija en el suelo mediante la taza "Bicchierino".

10) Regulación de los barrotes

Antes de bloquear los barrotes, hay que regular la pendencia en función de la contrahuella

11) Este diseño muestra el kit barra/contrahuella montado sobre el modelo GAMIA MADERA. Para la escalera GAMIA METAL las instrucciones de montaje son las mismas.

12) Completando el montaje de la escalera utilizar las bandas adhesivas antideslizantes

13) Montaje de la barandilla del rellano de desembarque

14) Montaje balaustra

-Montar los barrotes (ht. tot. 925 mm) metiendo el casquillo de expansión "Espa" y atornillando el mordente

-Señalar sobre el suelo el centro de los barrotes manteniendo la distancia desde el orificio de alrededor de 50 mm (la distancia entre los agujeros de los barrotes no tiene que superar los 120 mm)

- Perforar con una punta \varnothing 12 mm e introducir los expansores de nylon.

Deutsch

Beschreibung

Modulare Spindeltrappe aus Metall / Holz mit rundem Grundriss regulierbar mit Abstandstücken aus Metall

Anzahl der Stufen und Gesamthöhe der Treppe

11 + 1 Stufen : 2520 - 2760 mm

12 + 1 Stufen : 2730 - 2990 mm

13 + 1 Stufen : 2940 - 3220 mm

Stufen

Aus Stanzblech, mit rutschefeste klebestreifen

Steigungen

Standard Min. 210 mm; Max 230 mm (für Steigungen 200 ÷ 210 mm; 230 ÷ 240 mm verstellbar während der Montage).

Geländer

Mit Metallstäben Ø 22 mm (Distanz zwischen der Stäben max < 100 mm). Modulierbarer Handlauf aus Plastik (Höhe Handlauf = 1 m)

Oberflächenausführung und Farben

Metallteile: Epoxyd-Einbrennlackierung (Schwarz gaufriert).

Elemente aus Plastik, Auflagen und Schrauben: schwarz.

Kit

a) Verpackungseinheit mit 11 kompletten Stufen Ø 1200, 1400, 1600 mm

b) Verpackungseinheit mit komplettem Podest Ø 1250, 1450, 1650 mm

c) Verpackungseinheit mit zusätzlicher Stufe Ø 1200, 1400, 1600 mm

d) Verpackungseinheit Balustrade 1 m e) Verpackungseinheit „Sicherheit der Steigung“ für 11 Stufen (Kinder-Sicherung)

e) Verpackungseinheit „Sicherheit der Steigung“ für 11 Stufen (Kinder-Sicherung)

Vor Beginn der Treppemontage messen Sie das Treppenhaus nach. Um Beschädigungen zu vermeiden, überprüfen Sie vor Beginn der Montage, daß sich in dem Bereich, in dem die Treppe befestigt wird, keine Rohrleitungen oder elektrische Kabel befinden.

1) Die Spindel zusammenbauen.

2) Die Spindel vollkommen ausrichten und dabei das Austrittspodest als Anhaltspunkt benutzen.

3) Die Distanzstücke zusammenbauen und den Gewindeflansch auf die erforderlich Auftrittshöhe einstellen und lassen Sie zwischen eine Höhe von „Steigung - 170 mm“ feststellen.

4) Alle Elemente in die Spindel einsetzen: Plattenabdeckung, Distanzstücken, Stufen und Austrittsstufe.

5) Das Podest befestigen.

6) Den Abschlussflansch einsetzen.

7) Das Anschlußstück "Novia" aus den einzelnen Elementen zusammenbauen.

8) Die durchführenden Stäbe müssen durch die Stifte befestigt werden. Die andere Stäbe in allen Stufen mit den Expansions buchsen „Espa“ einsetzen.

9) Das erste Stab der Treppe wird geschnitten und mit dem "Bicchierino" befestigt.

10) Einstellung der Stäbe

Vor der Befestigung der Stäbe muß die Steigung in Abhängigkeit von der Stufenhöhe eingestellt werden.

11) Die Zeichnung betrifft die Kit "Sicherheit der Steigung" für das Modell Gamia Holz Was die Gamia Metall betrifft so ist die Montageanleitung die gleiche.

12) Fertig gestellt Montage der Treppe, gelten für sämtliche Stufen der rutschfeste Klebestreifen.

13) Montage des Geländerpodest

14) Montage der Balustrade

- Die Stäbe der Balustrade (H 925 mm) zusammenbauen, in dem die „Espa“
- Buchsen eingesetzt werden; dann die selbstschneidende Schraube anziehen, bis sie greift
- Auf dem Boden die Mitte der Stäbe für die Balustrade anzeichnen und dabei berücksichtigen, dass ein Abstand von der Öffnung von ca.50 mm eingehalten werden muss und dass der Abstand zwischen der Stäben nicht mehr als 120 mm betragen darf.
- Dann die Löcher mit einem Bohrer \varnothing 12 mm bohren und die Expansionselemente aus Nylon einsetzen: an diesem Punkt die Stäbe anschrauben und den Handlauf befestigen.

Português

Descrição

Escadaria em espiral modular em metal / madeira com planta circular regulável em alturas através de espaçadores metálicos interpostos entre os degraus.

Número de degraus e alturas alcançadas para escadas "nível-pavimento"

11 + 1 degraus : 2520 - 2760 mm

12 + 1 degraus : 2730 - 2990 mm

13 + 1 degraus : 2940 - 3220 mm

Degraus

Em chapa estampada, com fita adesiva antiderrapante

Alturas do degrau

Standard Mín. 210 mm; Máx 230 mm (para alturas do degrau $200 \div 210$ mm; $230 \div 240$ mm podem-se adaptar as colunas na fase de instalação).

Parapeito

De colunas em tubo de metal \varnothing 22 mm (luz máx entre as colunas < 100 mm). Corrimão de material plástico flexível (ht. corrimão = 1 m).

Acabamento e cores

Peças em metal: pintadas com pó epóxico em forno (Preto gofrado).
Componentes em plástico, borracha e parafuso: preto.

Kit

- a) Embalagem nr. 11 degraus simples completos \varnothing 1200, 1400, 1600 mm
- b) Embalagem patamar de chegada completo \varnothing 1250, 1450, 1650 mm
- c) Embalagem degrau simples adicional \varnothing 1200, 1400, 1600 mm
- d) Embalagem balaústre 1 m
- e) Embalagem "escora / altura do degrau" para nr. 11 degraus

Verifique as dimensões da caixa de escada antes de prosseguir com a instalação. Controlar se nas zonas onde serão efetuadas as fixações da escada, não existem tubos ou cabos elétricos, a fim de evitar danos

- 1) Montar o poste.
- 2) Colocar o poste em referência com o orifício, dispondo o degrau de chegada no lado de saída da escada
- 3) Regular os espaçadores de plástico apertando a bucha roscada, deixando entre as duas linhas uma distância igual a "Altura do degrau - 170 mm".
- 4) Inserir os elementos no poste a partir do cobre-placa na parte inferior, continuando com os espaçadores e os degraus, até à introdução do degrau de chegada.
- 5) Das Podest befestigen.
- 6) Inserir no poste a flange terminal.
- 7) Regular a ligação "Novia" montando os elementos.

8) Inserir as colunas em todos os degraus, bloqueando as passantes com os graus e as que se encontram sobre o degrau com a bucha de expansão “Espa”.

9) A primeira coluna da escada deve ser cortada e fixada no solo através do “Encaixe”.

10) Regulação das colunas

Antes de bloquear as colunas efetuar a regulação da pendência, em relação à altura do degrau.

11) Este desenho mostra o kit “escora/altura do degrau” montado no mod. GAMIA LEGNO. Para a escada GAMIA METALLO as instruções de montagem são as mesmas.

12) Concluída a instalação da escada, aplicar em todos os degraus as fitas adesivas antiderrapantes.

13) Montagem do balaústre do degrau de chegada.

14) Montagem do Balaústre

- Montar as colunas (ht. 925 mm) introduzindo a bucha “Espa” e apertando o encaixe
- Marcar no pavimento o centro das colunas mantendo a distância do furo de cerca de 50 mm (a distância entre as colunas não deve ser superior a 120 mm)
- Perfurar com uma broca de \varnothing 12 mm e introduzir os expansores de nylon.

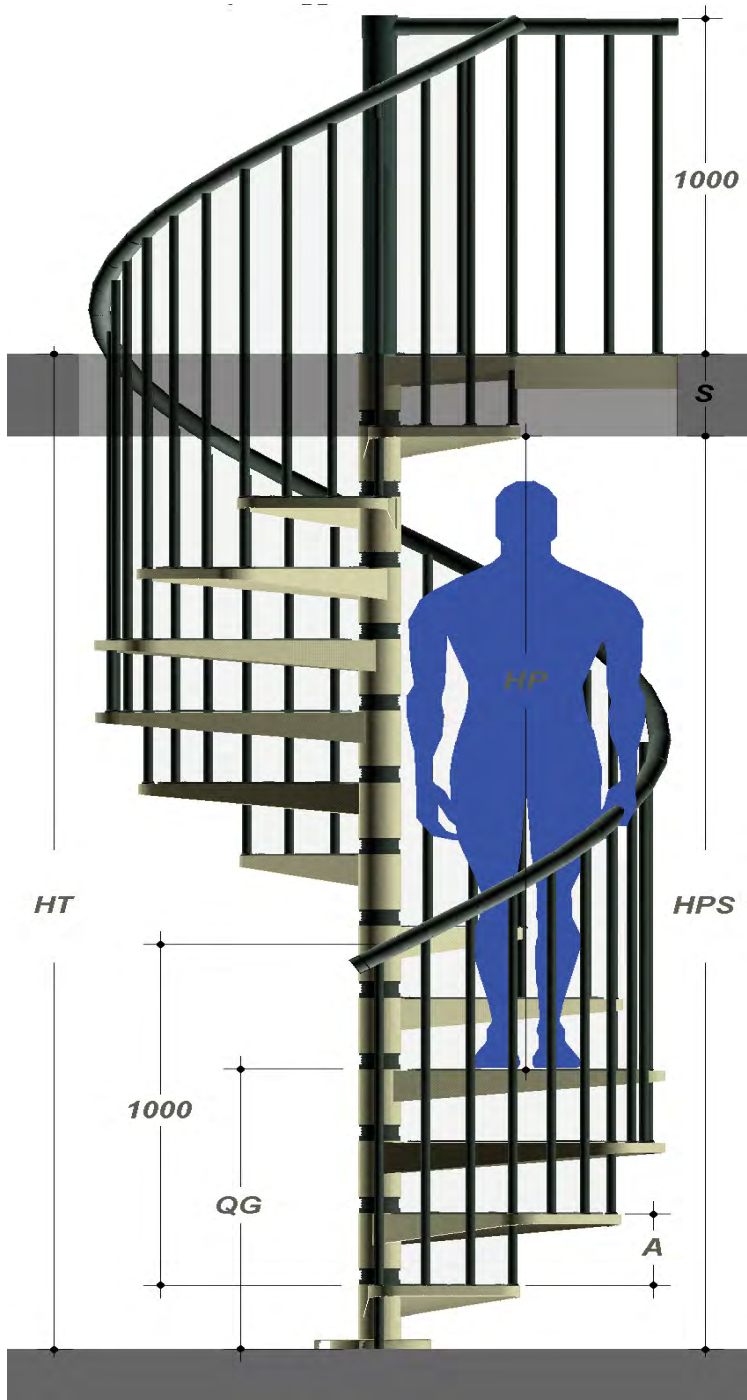

HT - Altezza totale da pavimento a pavimento (HPS+S)
 HPS - Altezza da pavimento inferiore a soffitto (HT-S)
 S - Spessore solaio (HT-HPS)
 A - Altezza alzata (HT/Nr. alzate)

HT - Hauteur totale sol fini à sol fini (HPS+S)
 HPS - Hauteur sous plafond (HT-S)
 S - Epaisseur de la dalle (HT-HPS)
 A - Hauteur de la marche
 (Hauteur totale:n.hauteurs de marches)

HT - Altura total de suelo a suelo (HPS+S)
 HPS - Altura de suelo inferior a techo (HT-S)
 S - Espesor de la losa o piso (HT-HPS)
 A - Altura contrahuella (HT / Nr. contrahuellas)

HT - Floor-to-floor height (HPS+S)
 HPS - Floor-to-ceiling height (HT-S)
 S - Floor thickness (HT-HPS)
 A - Riser height (HT : riser number)

HT - Höhe Oberkante Fertigfußboden / Oberkante Fertigfußboden (HPS+S) "93Stockwerkshöhe"93
 HPS - Höhe Oberkante Fertigfußboden / Decke (HT-S)
 S - Deckenstärke (HT-HPS)
 A - Steigung (HT : Anzahl der Steigungen)

HT - Altura total de pavimento a pavimento (HPS+S)
 HPS - Altura do pavimento inferior ao teto (HT - S)
 S - Espessura soalho (HT - HPS)
 A - Altura do degrau (HT/Nr. Alturas do degrau)

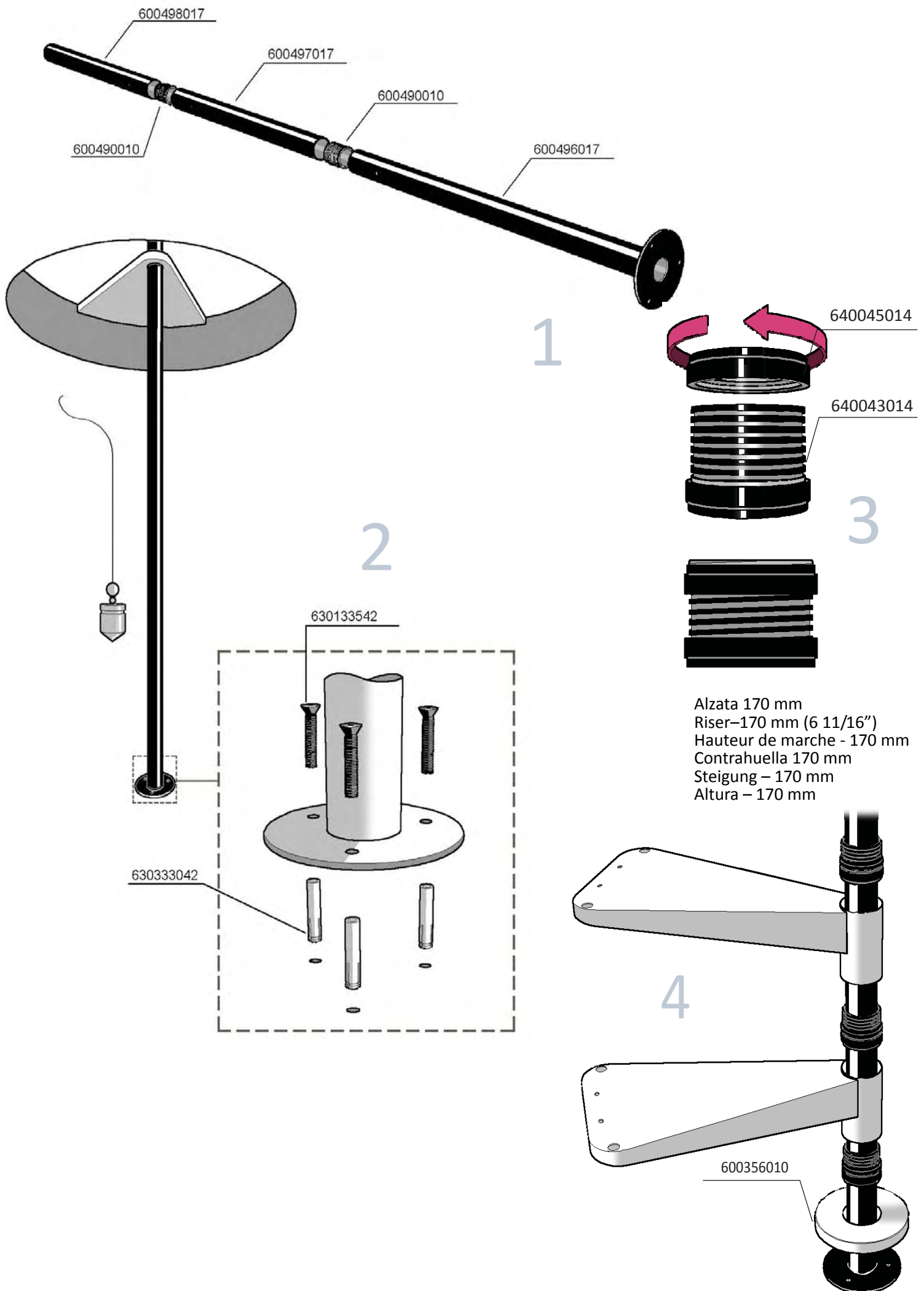

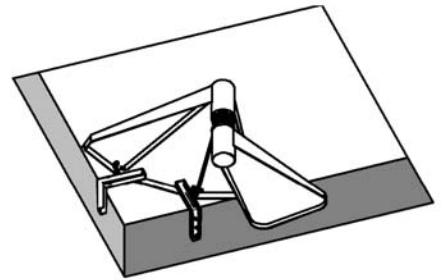
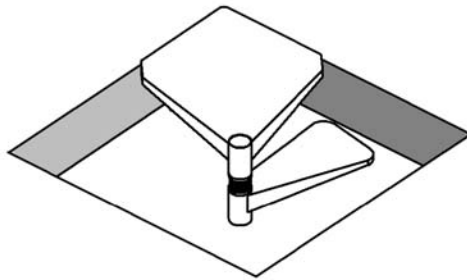
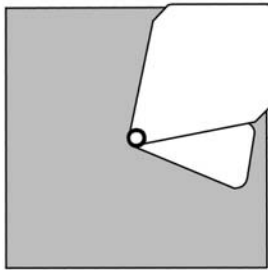
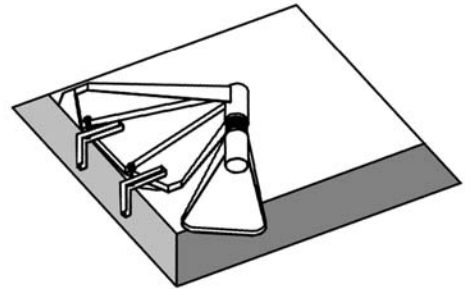
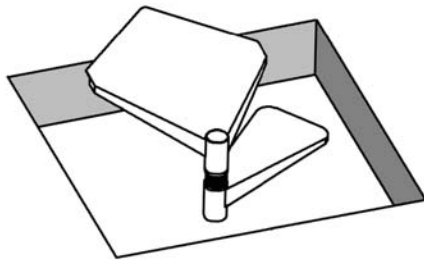
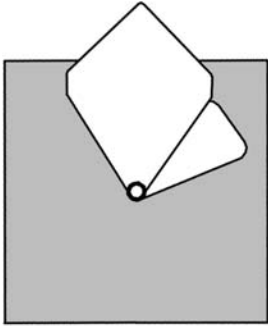
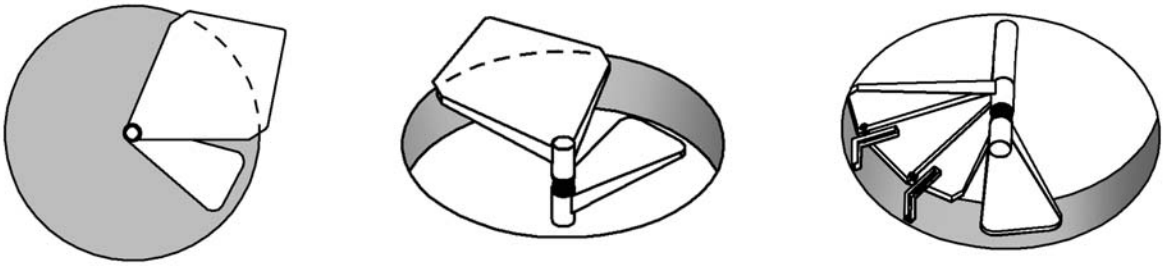

5

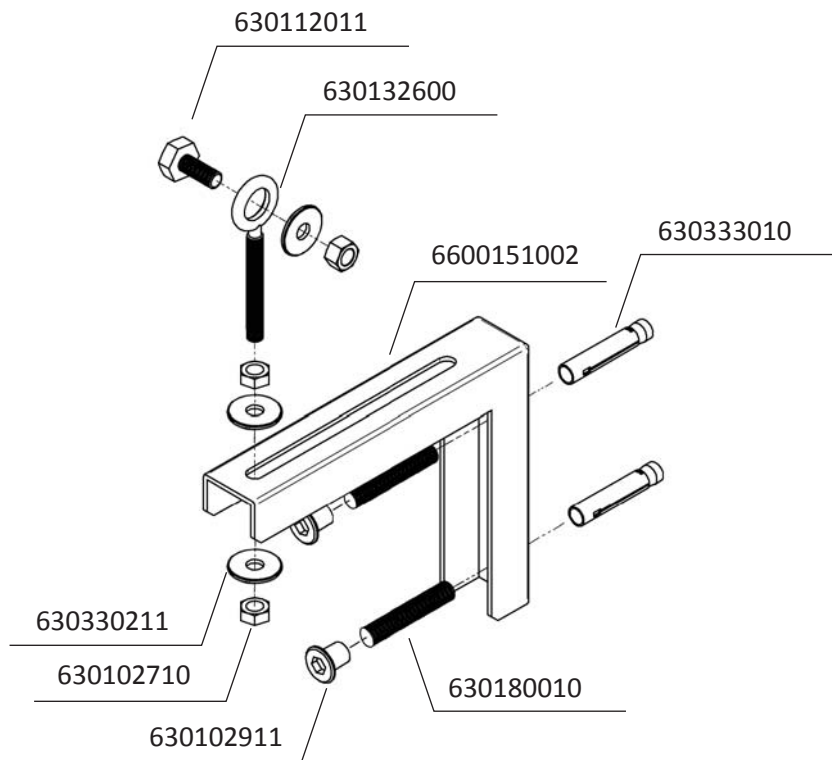

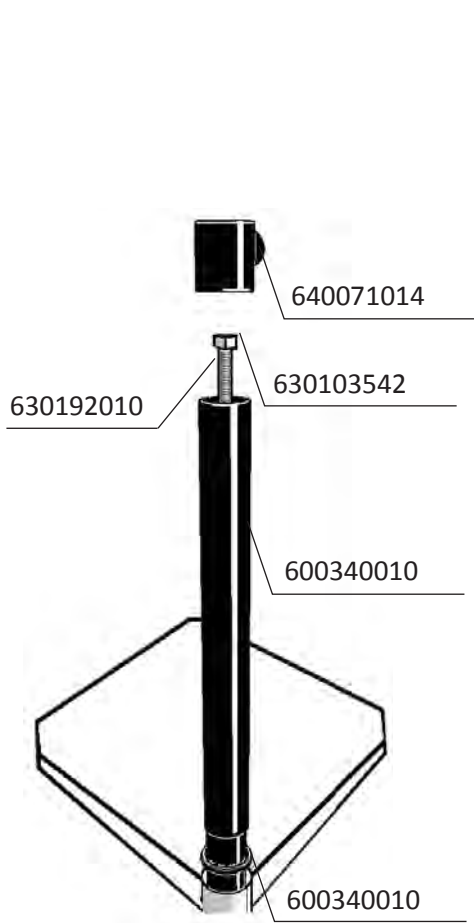

6

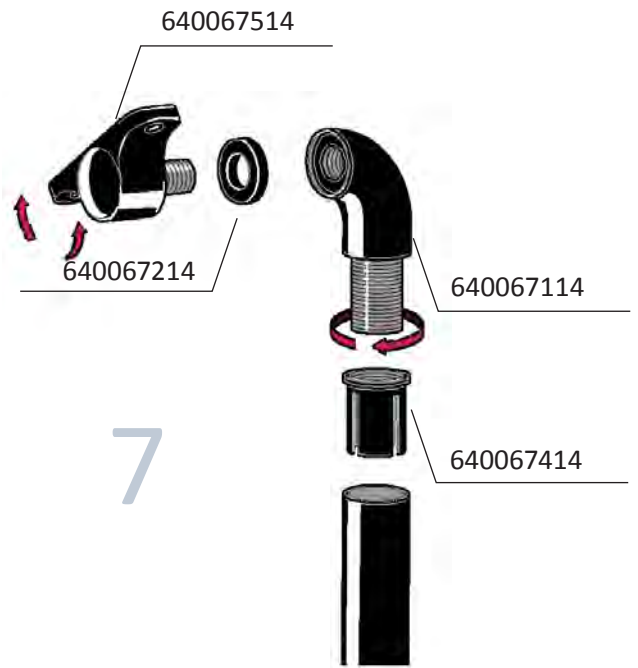

7

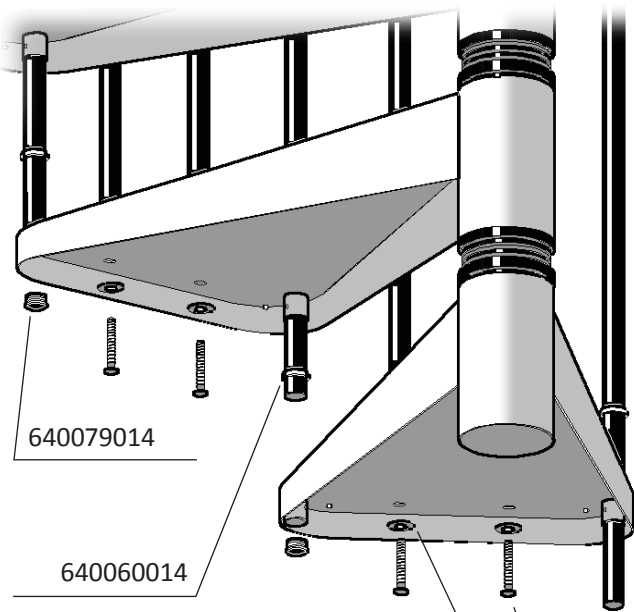

8

63013242

630331442

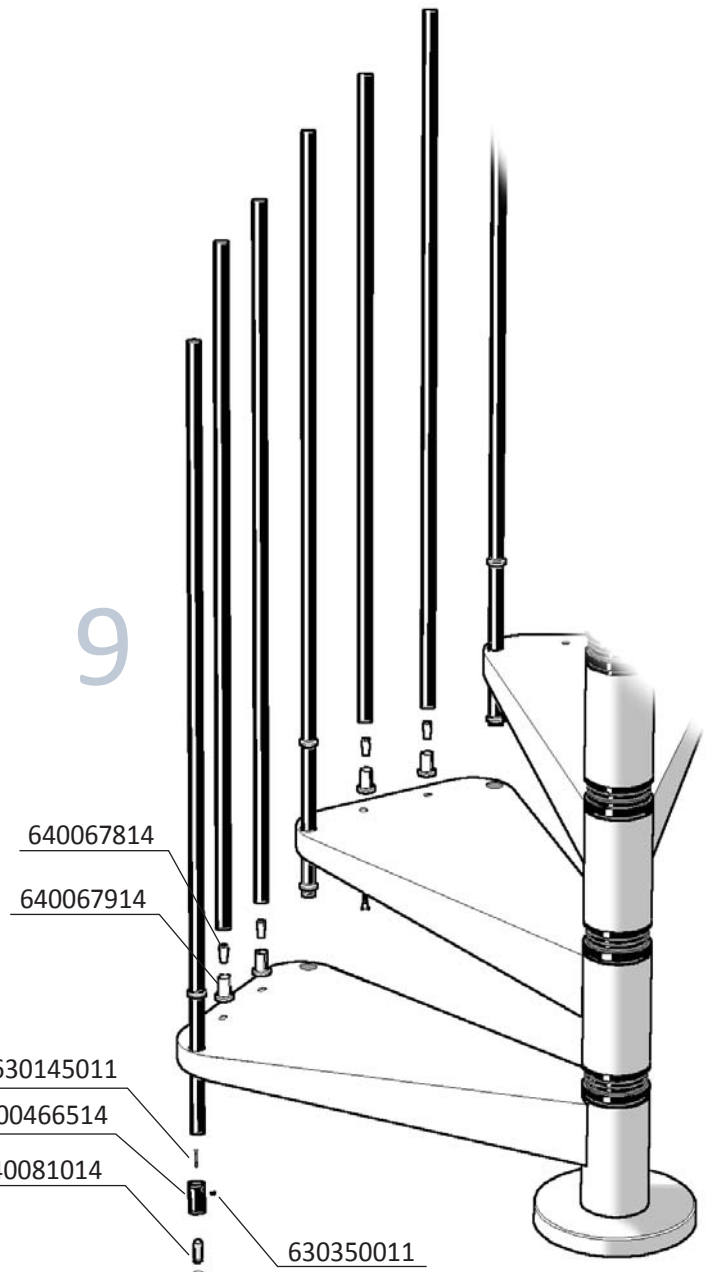

9

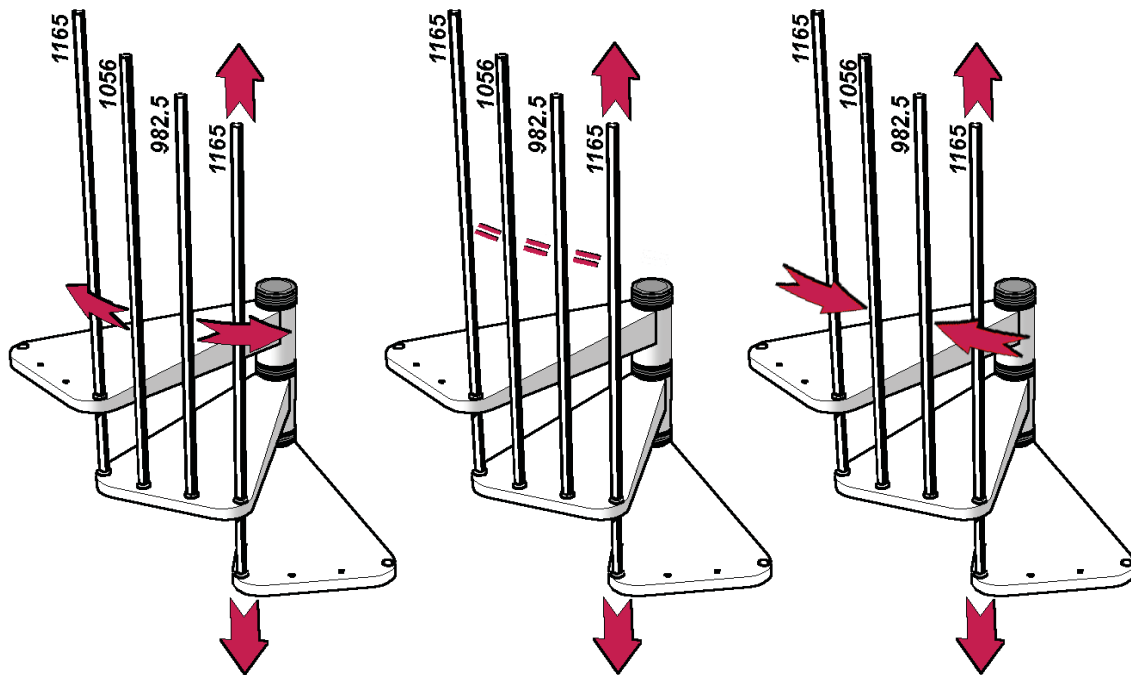

Ø scala / stair/ escalier / escalera/ treppe/ escada
120 – 140 mm; (47 1/4" - 55 1/8");

10

Ø scala / stair/ escalier / escalera/ treppe/escada
160 mm (63")

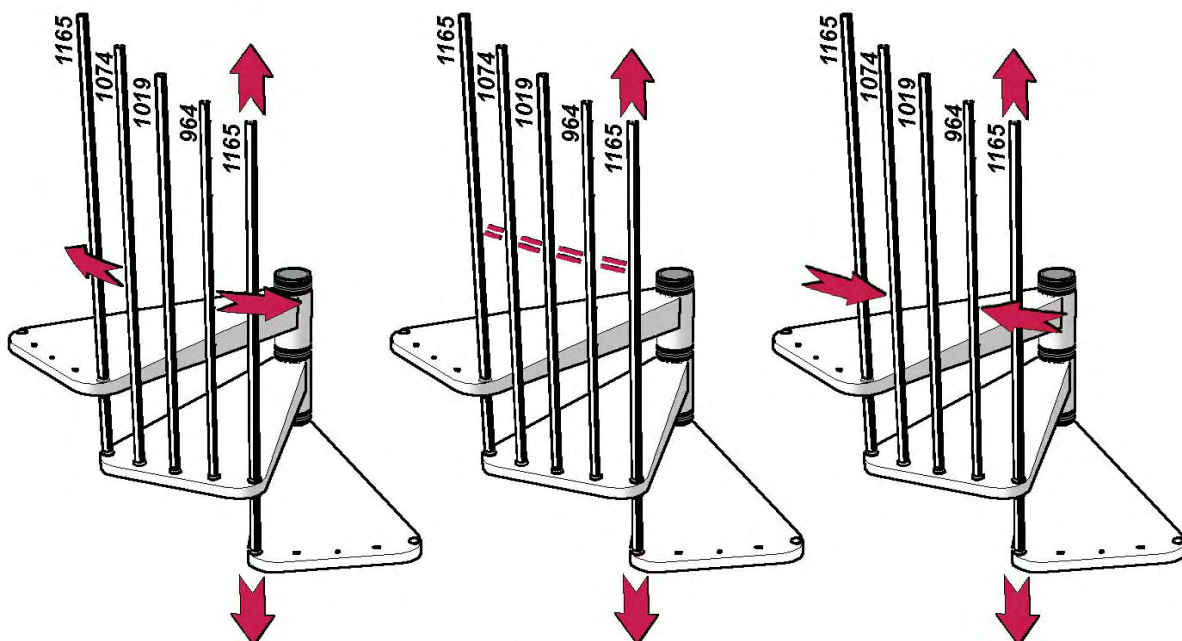



11

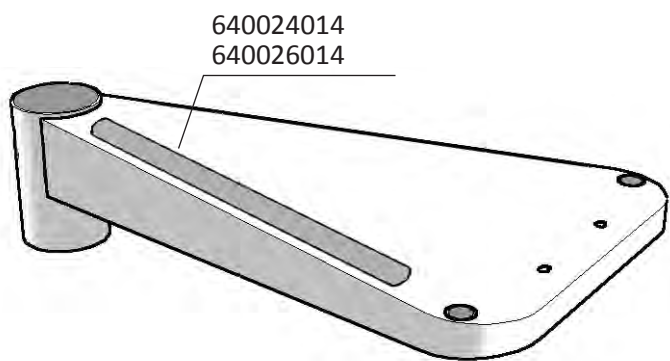



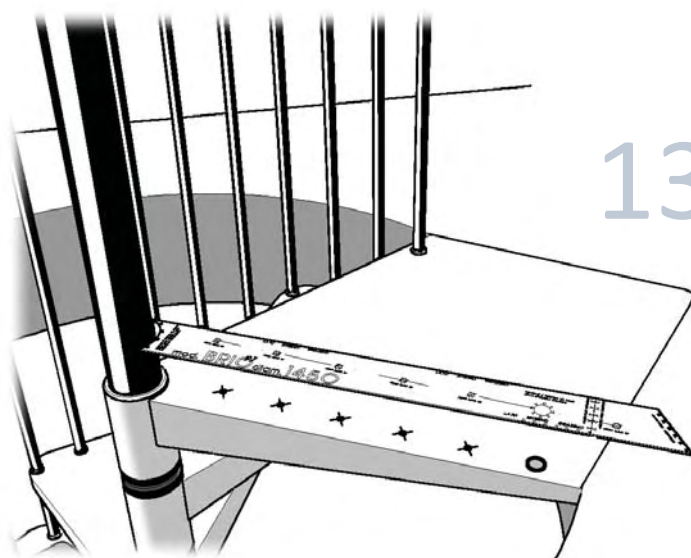



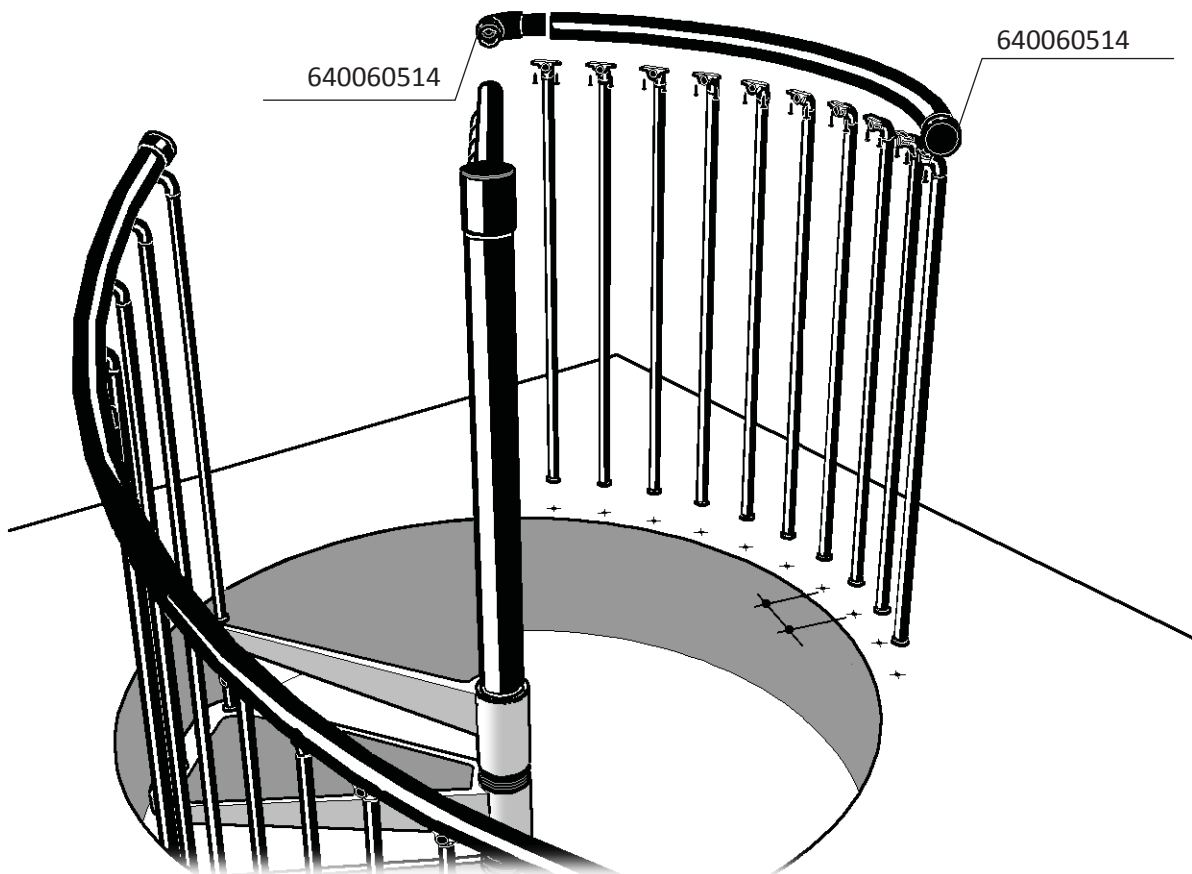
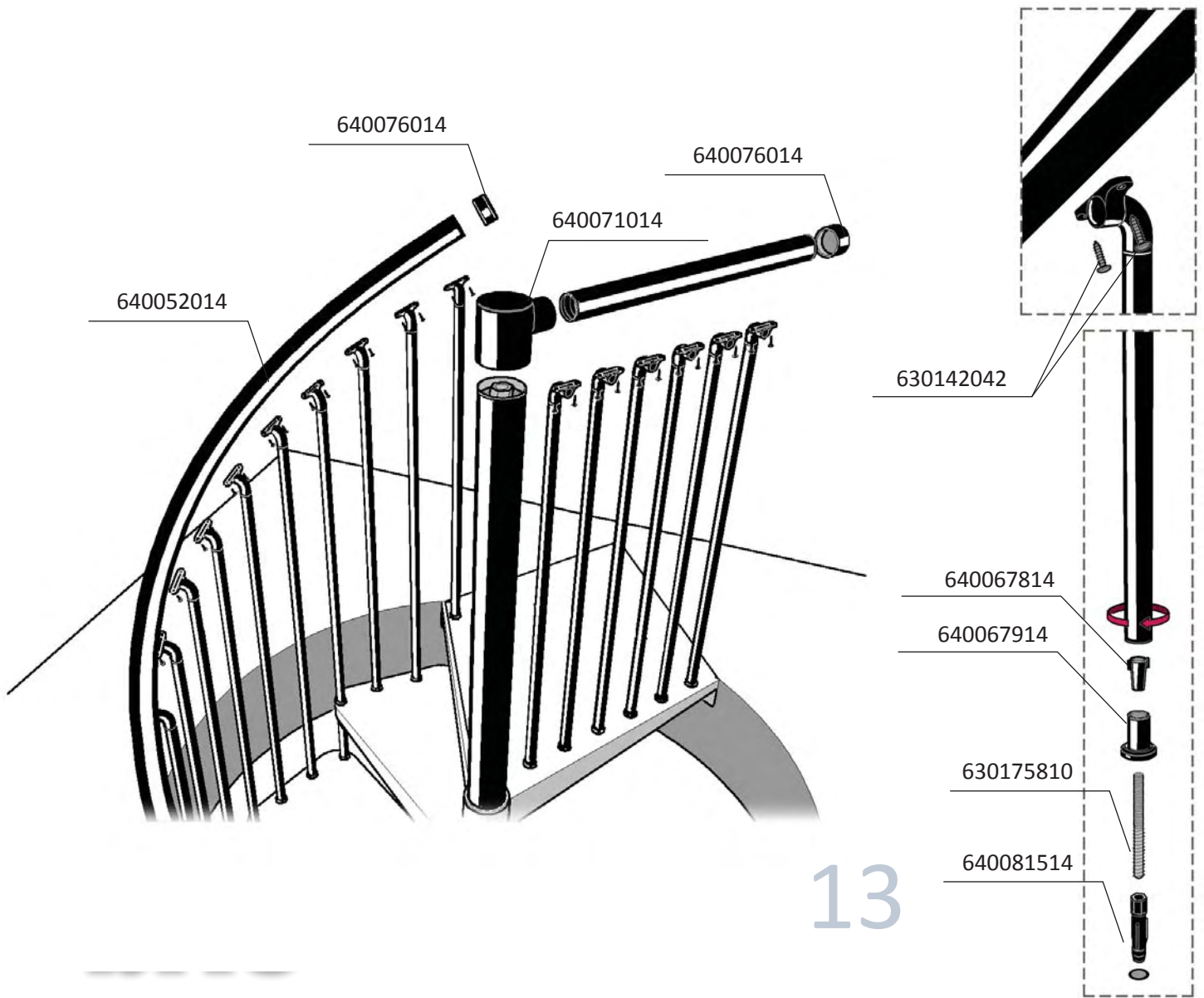

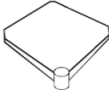
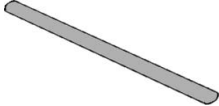
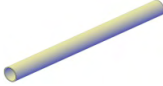
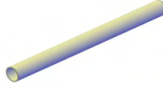
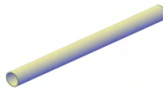
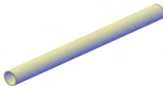
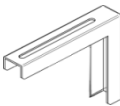















12















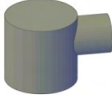



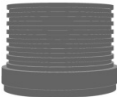





13

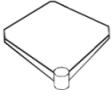
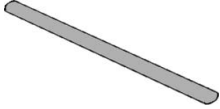
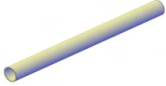
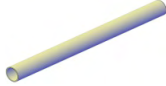
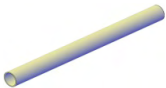
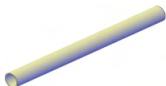
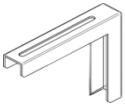































Ø 1200	KIT 12+1	COD.	IMAGE
	12	600042002	
	1	600100202	
	13	640024014	
	5	600230514	
	12	600231714	
	12	600232514	
	14	600233014	
	2	600151002	
	1	600343002	
	1	600356002	
	2	600490000	
	1	600496002	
	1	600497002	
	1	600498002	
	1	600340002	
	1	600467514	

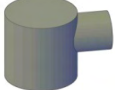
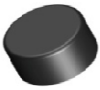







Ø 1200	KIT 12+1	COD.	IMAGE
	2	600466514	
	1	630103510	
	6	630102710	
	88	630142011	
	2	630145011	
	4	630180010	
	2	630132600	
	3	630133511	
	30	630132011	
	2	630112011	
	1	630192000	
	42	630350011	
	7	630333010	
	4	630102911	
	30	630331411	
	6	630330211	

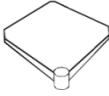
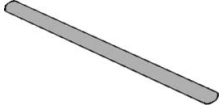
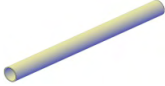
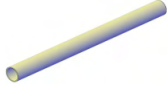
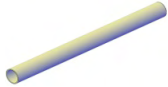
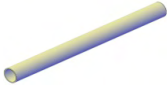
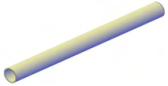
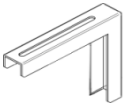















Ø 1200	KIT 12+1	COD.	IMAGE
	1	9964520	
	44	640067114	
	44	640067214	
	44	640067414	
	44	640067514	
	1	640071014	
	3	640076014	
	12	640079014	
	1	650800000	
	13	640043014	
	13	640045014	
	30	640067814	
	30	640067914	
	2	640081014	
	27	640060014	













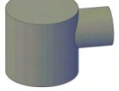

Ø 1400	KIT 12+1	COD.	IMAGE
	12	600044002	
	1	600100402	
	13	640026014	
	5	600230514	
	12	600231714	
	12	600232514	
	14	600233014	
	2	600151002	
	1	600343002	
	1	600356002	
	2	600490000	
	1	600496002	
	1	600497002	
	1	600498002	
	1	600340002	
	1	600467514	

Ø 1400	KIT 12+1	COD.	IMAGE
	2	600466514	
	1	630103510	
	6	630102710	
	88	630142011	
	2	630145011	
	4	630180010	
	2	630132600	
	3	630133511	
	30	630132011	
	2	630112011	
	1	630192000	
	42	630350011	
	7	630333010	
	4	630102911	
	30	630331411	
	6	630330211	

Ø 1400	KIT 12+1	COD.	IMAGE
	-	9964520	
	1	9964525	
	44	640067114	
	44	640067214	
	44	640067414	
	44	640067514	
	1	640071014	
	3	640076014	
	11	640079014	
	1	650800000	
	13	640043014	
	13	640045014	
	30	640067814	
	30	640067914	
	2	640081014	
	27	640060014	

Ø 1600	Q. KIT 12+1	COD.	IMAGE
	12	600044002	
	1	600100402	
	13	640026014	
	6	600230514	
	12	600231714	
	12	600232514	
	12	600232714	
	14	600233014	
	2	600151002	
	1	600343002	
	1	600356002	
	2	600490000	
	1	600496002	
	1	600497002	
	1	600498002	
	1	600340002	

Ø 1600	Q. KIT 12+1	COD.	IMAGE
	2	600467514	
	3	600466514	
	1	630103510	
	6	630102710	
	114	630142011	
	3	630145011	
	4	630180010	
	2	630132600	
	3	630133511	
	43	630132011	
	2	630112011	
	1	630192000	
	43	630350011	
	7	630333010	
	4	630102911	
	43	630331411	

Ø 1600	Q. KIT 12+1	COD.	IMAGE
	6	630330211	
	1	9964525	
	57	640067114	
	57	640067214	
	57	640067414	
	57	640067514	
	1	640071014	
	3	640076014	
	12	640079014	
	1	650800000	
	13	640043014	
	13	640045014	
	43	640067814	
	43	640067914	
	3	640081014	
	26	640060014	