

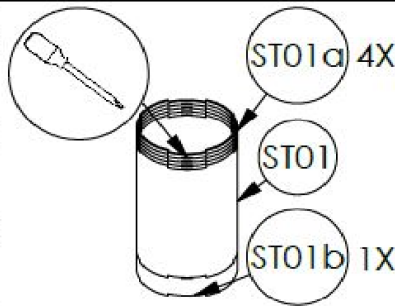

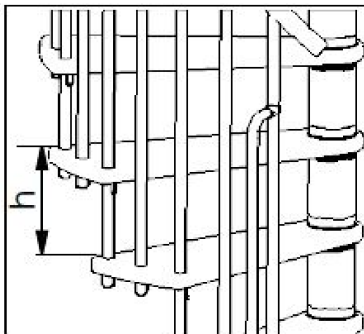

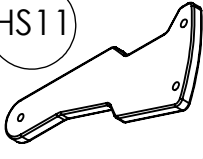

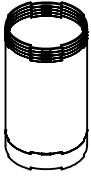

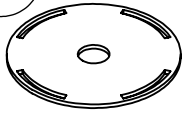

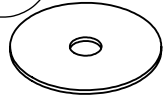
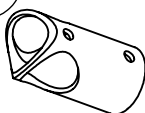
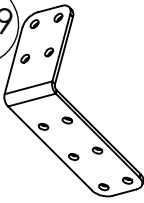

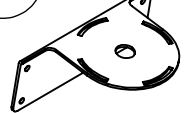

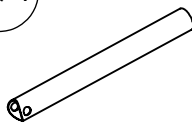
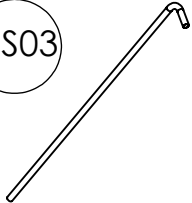
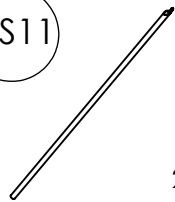
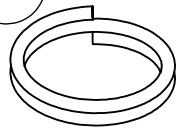
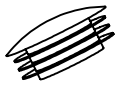
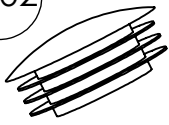
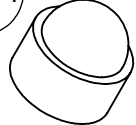
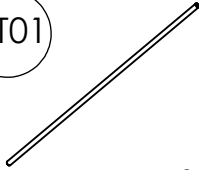
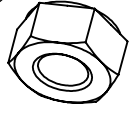
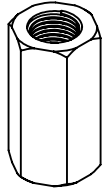
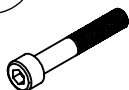
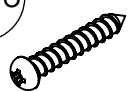

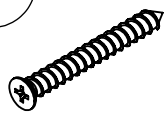

max. 200 kg

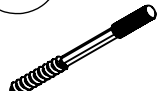

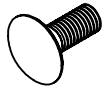
	h	ST01a	ST01b
h1	190 mm	0x	0x
h2	195 mm	1x	0x
h3	200 mm	2x	0x
h4	205 mm	3x	0x
h5	210 mm	4x	0x
h6	215 mm	0x	1x
h7	220 mm	1x	1x
h8	225 mm	2x	1x
h9	230 mm	3x	1x
h10	235 mm	4x	1x

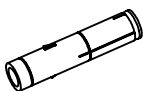
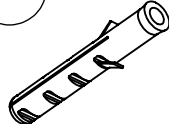
 HS11 12x	 ST01 12x Ø 108x200 mm	 ST02 23x	 ST03 1x	 ST06u 1x Ø 100 x 3 mm
 ST07 3x	 ST09 2x	 ST11 24x	 ST56 1x	 ST90 1x
 ST91 1x	 GS03 2x Ø 22x1x913+170mm	 GS11 25x Ø 22x2x1260 mm	 G01 1x Ø 40x3x6000mm	 KS01 12x Ø 22 mm
 KS02 2x Ø 40 mm	 KS04 1x M20	 NT01 3x M20x1000 mm	 NT02 6x M20 DIN 934	 NT04 2x M20 DIN 6334
 NT05 4x M8x50 mm	 NT06 48x Ø 5 x 30 mm	 NT07 30x 4,2 x 19mm	 NT09 8x 6 x 30mm	 NT10 18x 6 x 50mm
 NT11 50x Ø 4x25mm	 NT47 12x M6 x 60 mm	 NT48 15x M6	 NT49 3x M6	 NT50 12x M6 DIN 125
 NT52 1x M8 x 35 mm	 NT53 1x M8	 D01 4x Ø 12 mm	 D02 19x Ø 8mm	 S01 1x

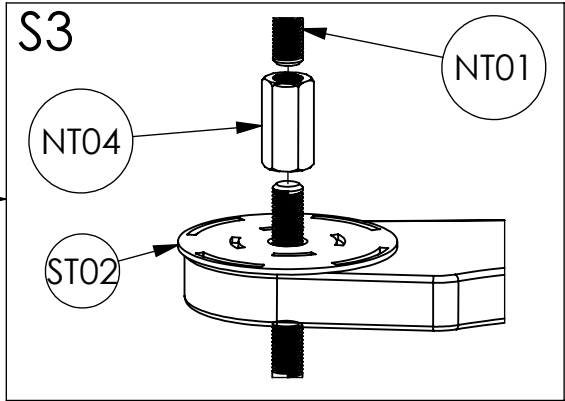
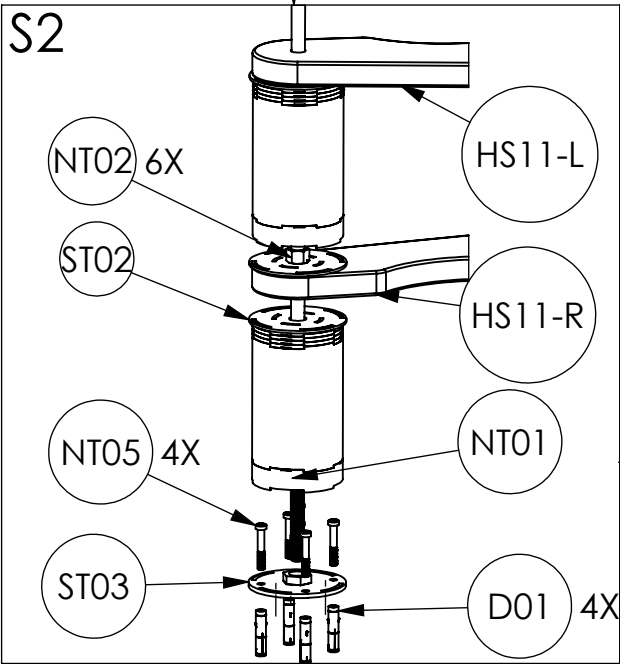
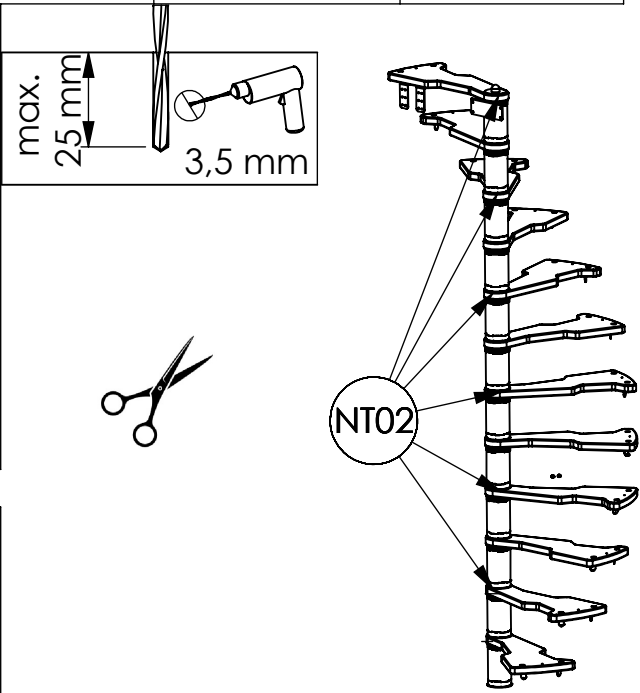
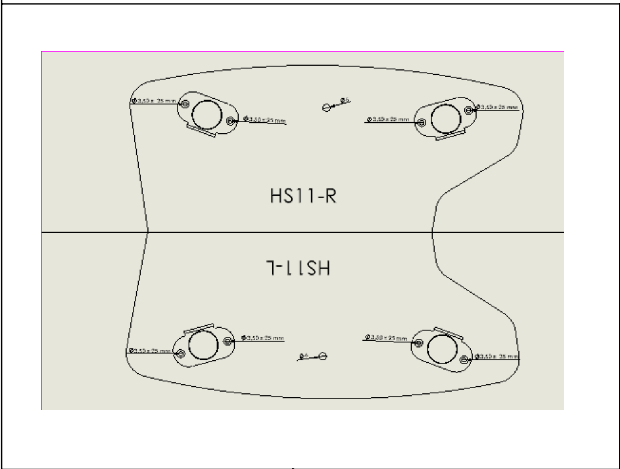
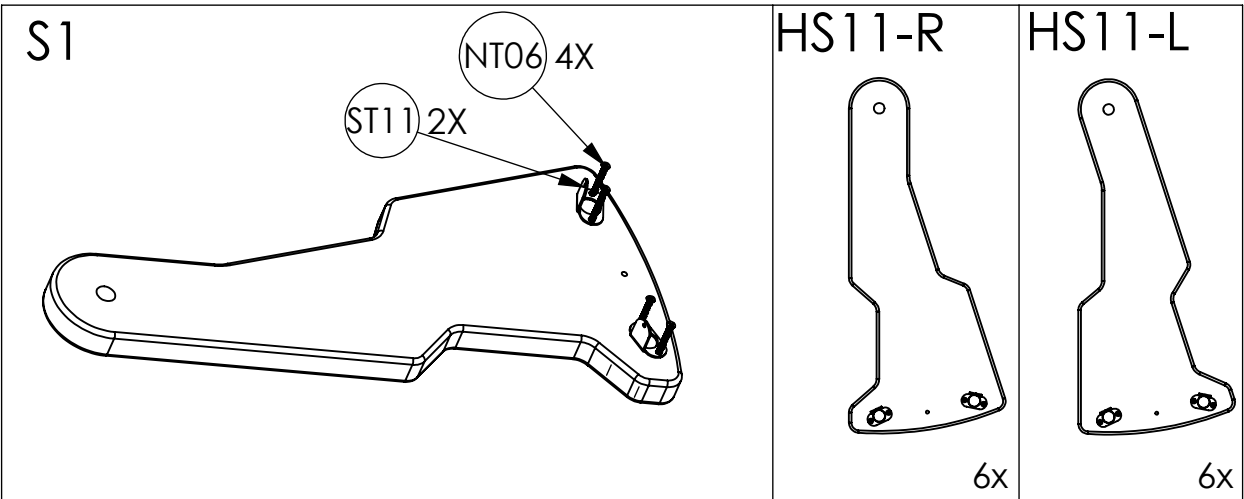

3

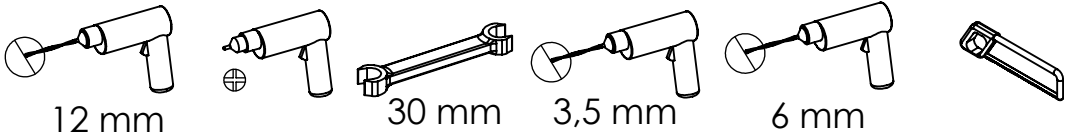

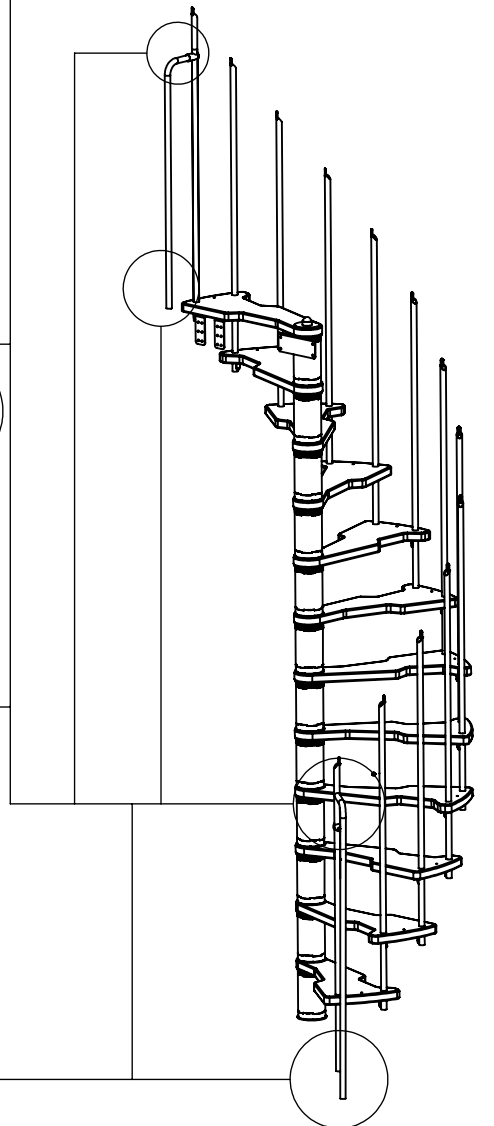
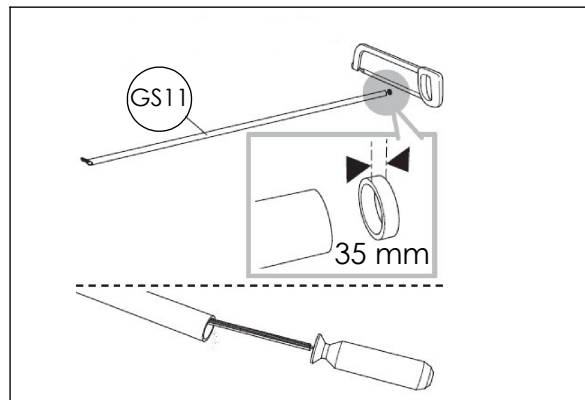
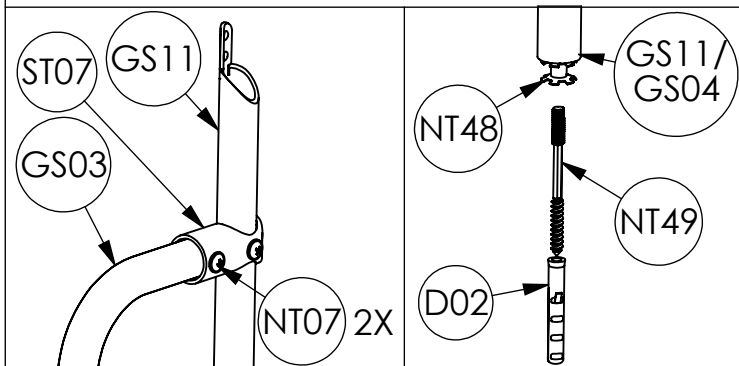
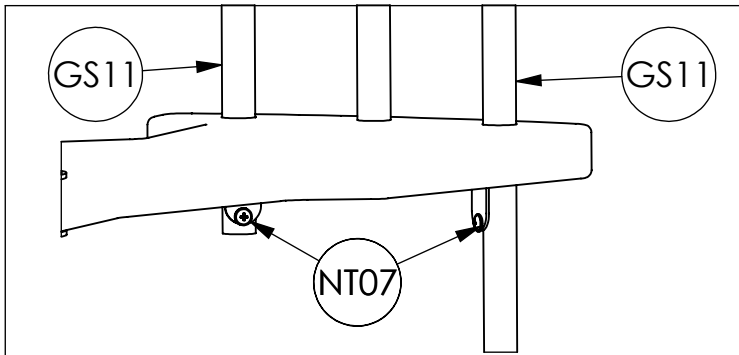
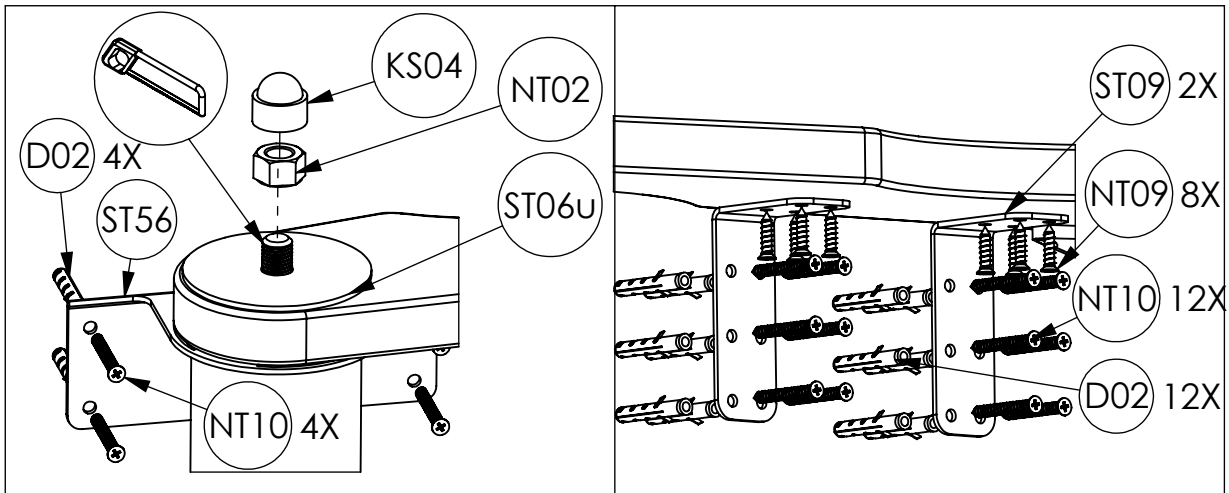

4

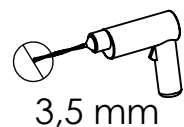
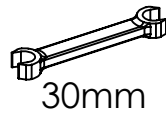
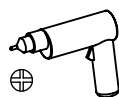
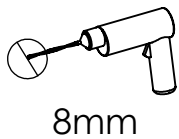

OPTION

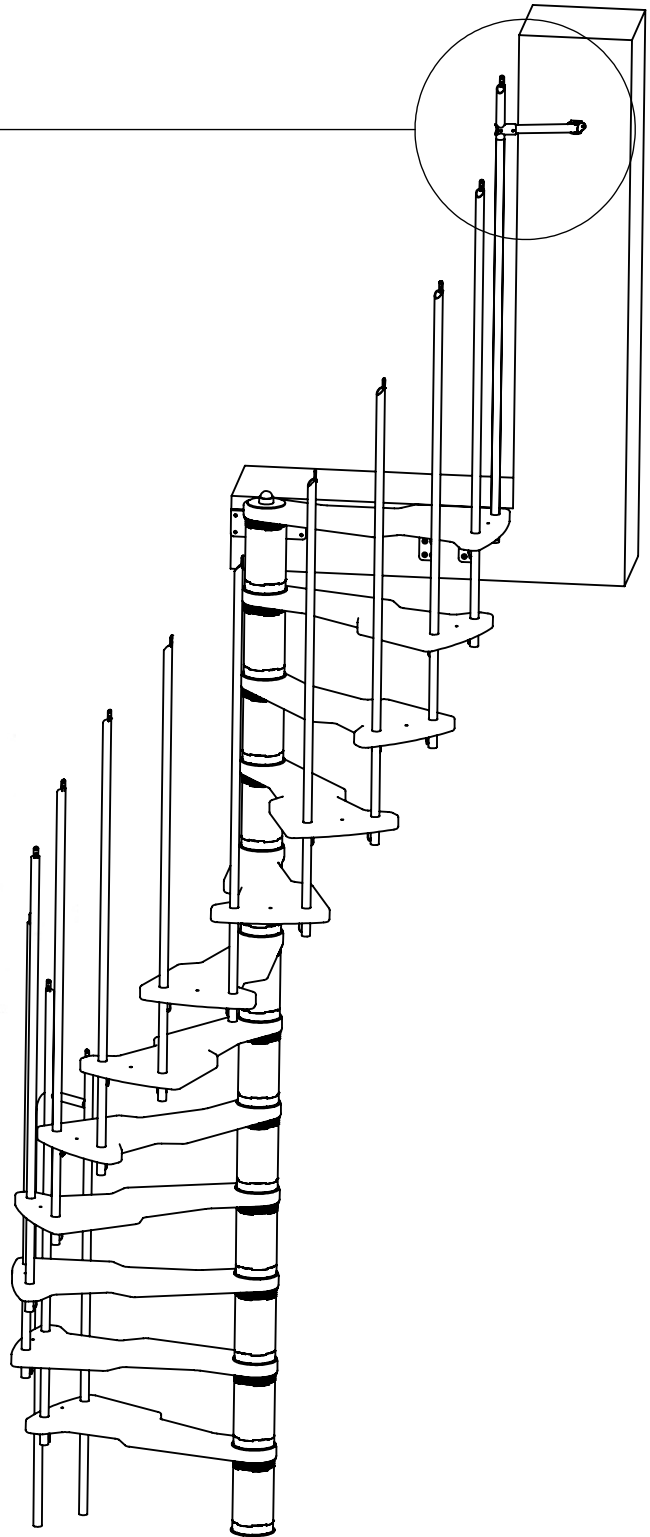
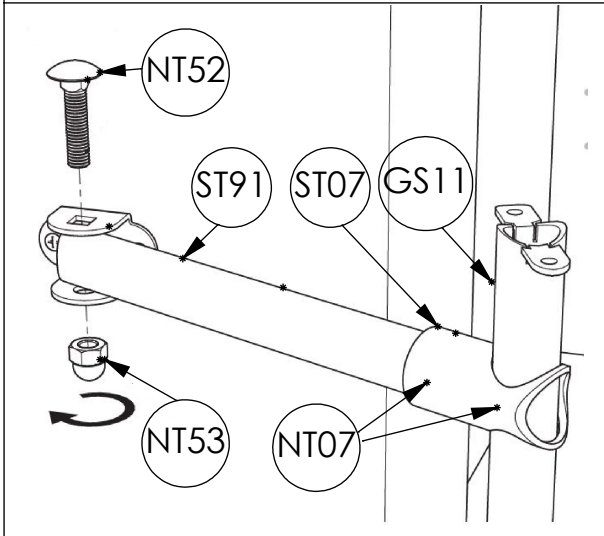
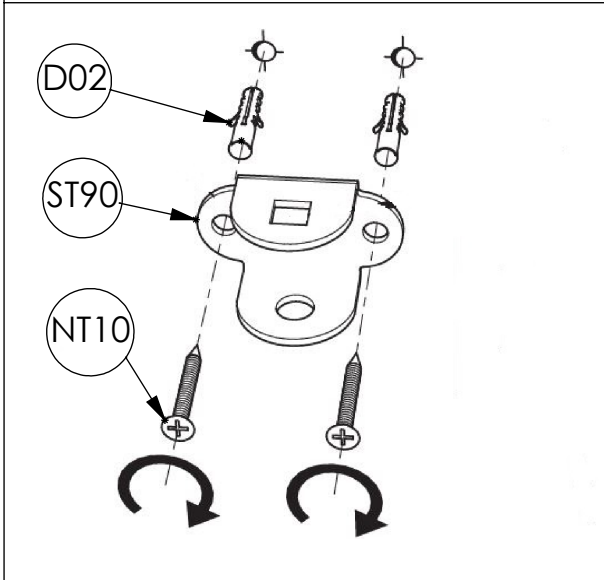
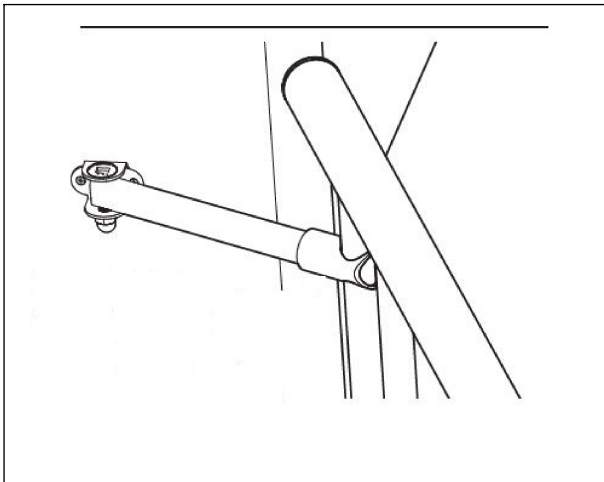

5

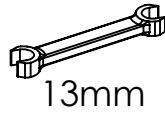
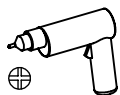
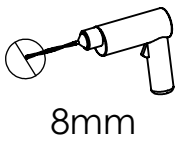

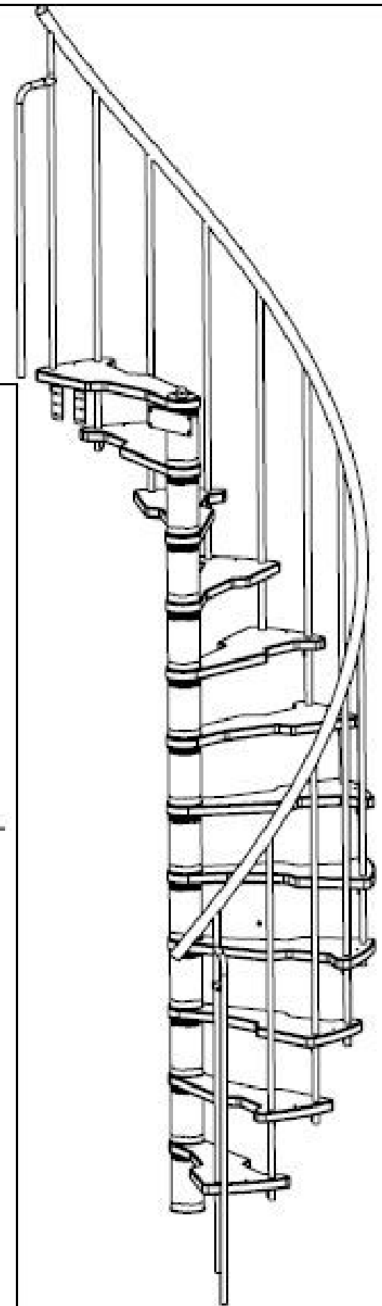
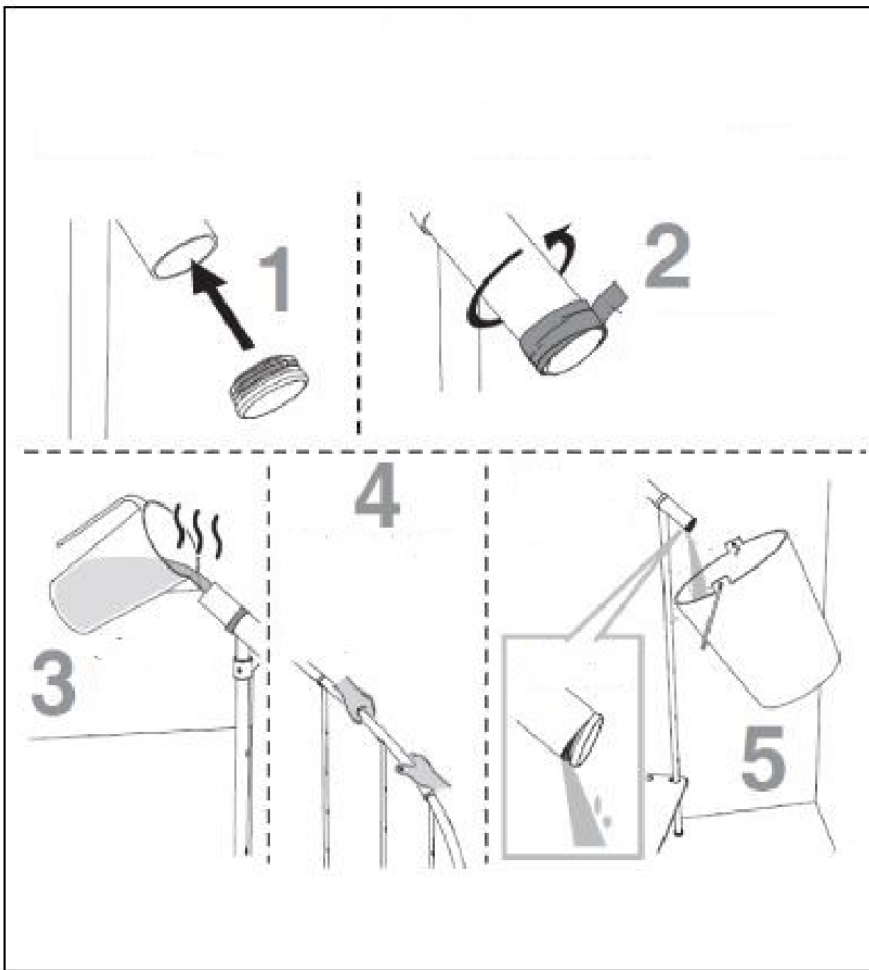
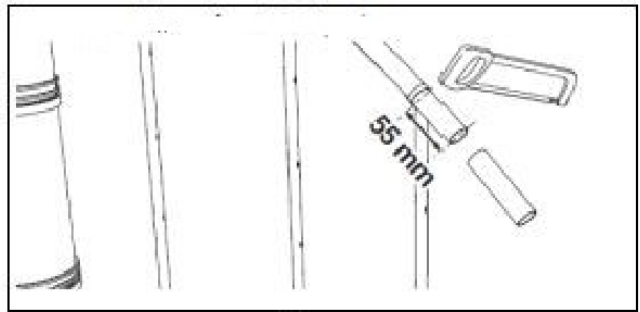
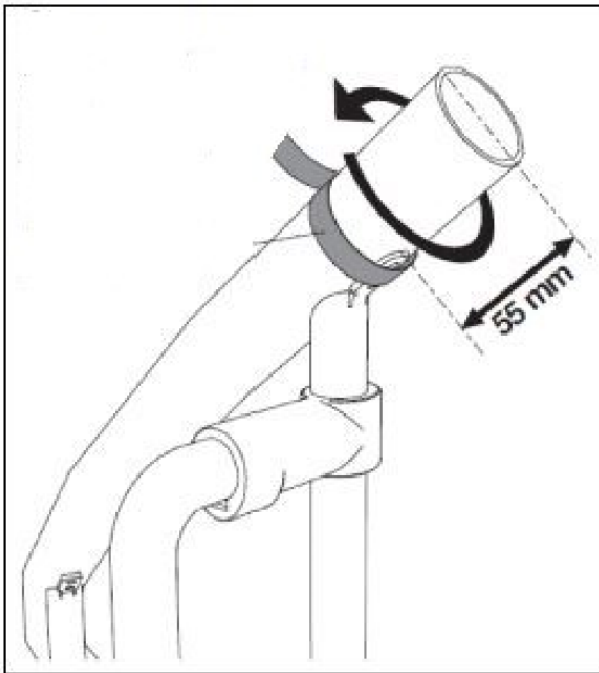

6

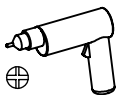

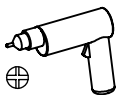
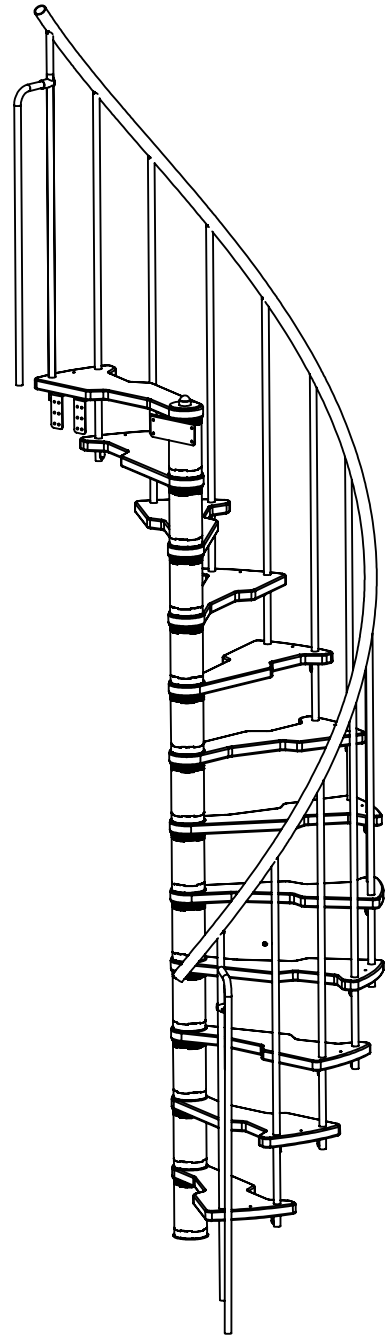
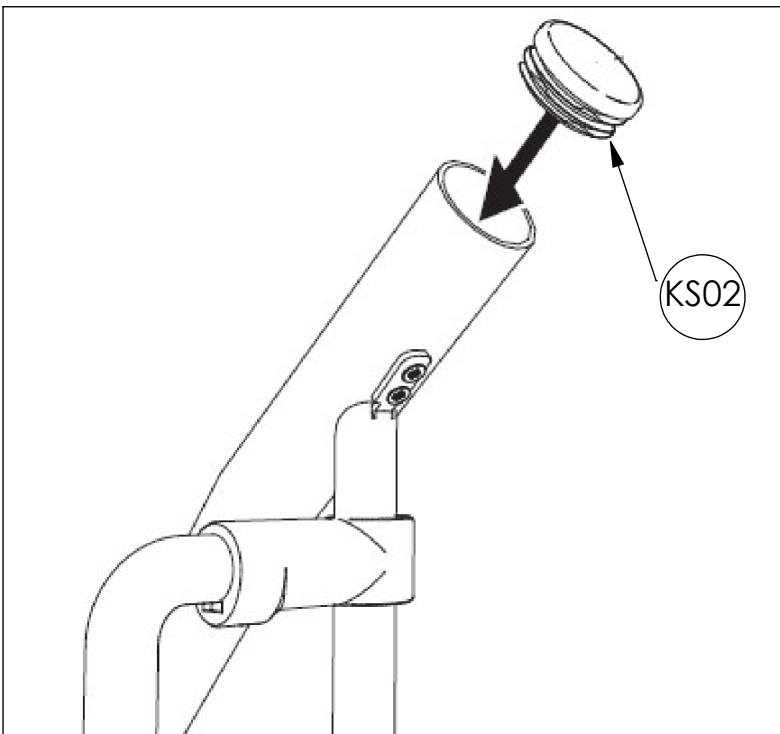
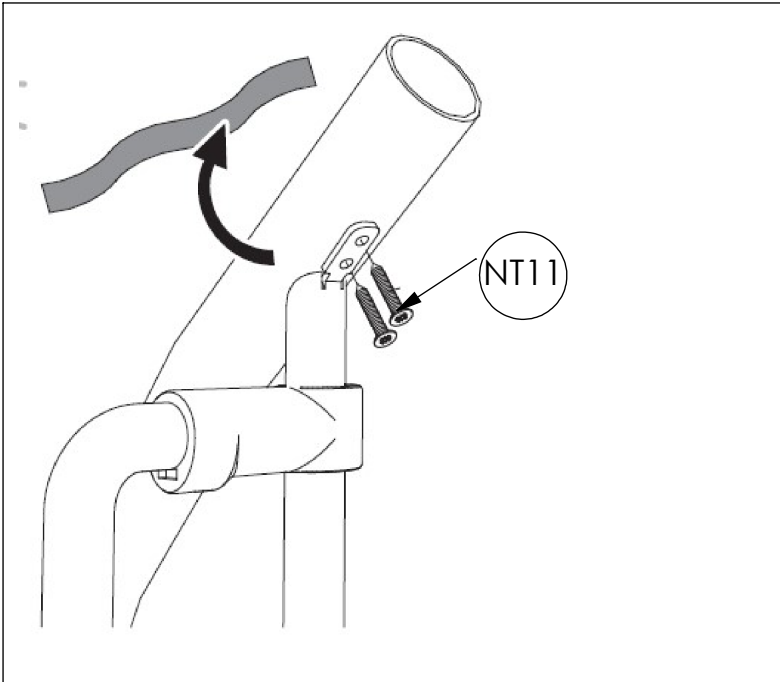

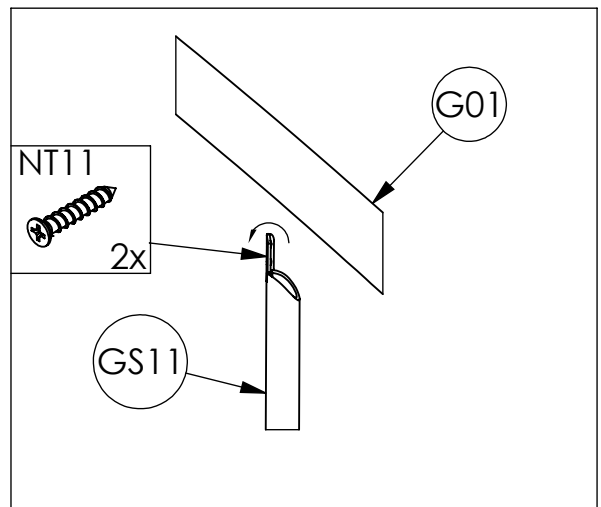
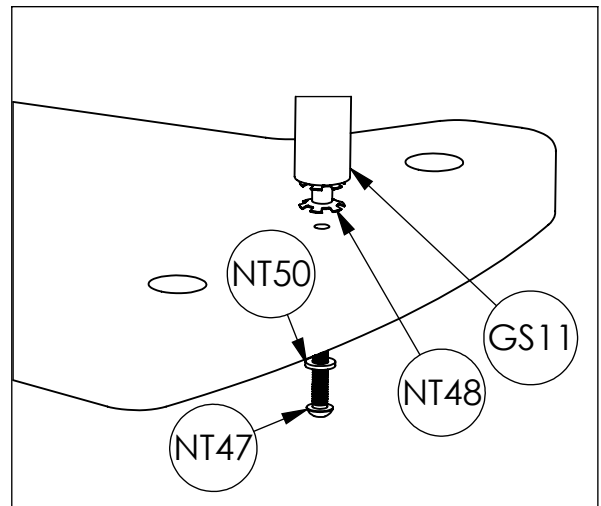
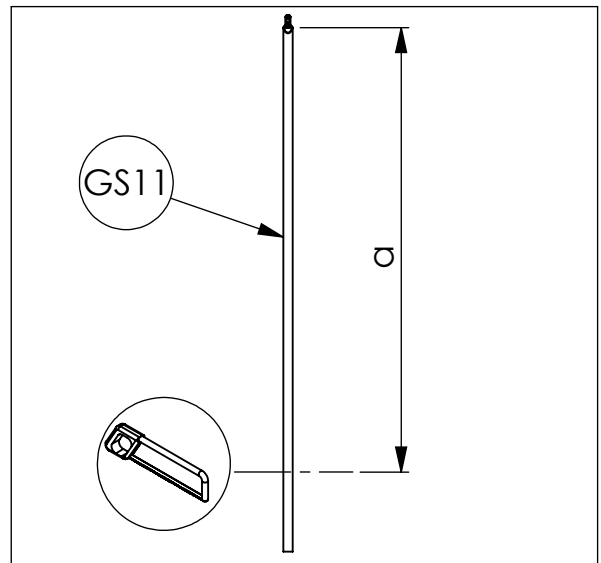
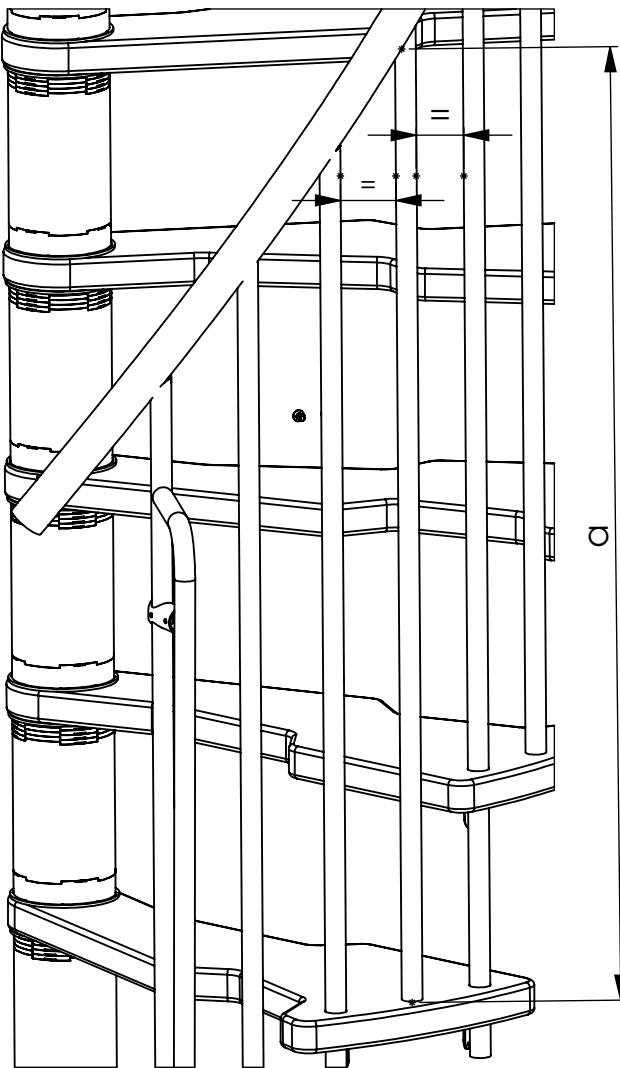

8

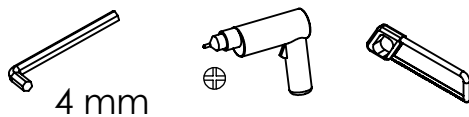

4 mm