

NOVA



Scala a chiocciola disponibile con forma tonda;

Gradini in legno di faggio;

Palo centrale in metallo;

Ringhiera con colonne in acciaio verniciato;

Corrimano:

1. **NOVA** in pvc effetto legno, tinta naturale o tinta noce, unico elemento continuo;
2. **NOVA CL** in legno massiccio suddiviso in settori.



Spiral staircase available with round shape;

Beech wood steps;

Central pole in metal;

Banister composed of painted steel columns;

Handrail:

1. **NOVA** in wood-effect PVC, natural or walnut colored, a single continuous element;
2. **NOVA CL** made of solid wood divided into sectors.



Escalier en colimaçon disponible ronde;

Marches en bois de hêtre ;

Poteau central en métal;

Rampe avec colonnes en acier vernissé;

Main courante:

1. **NOVA** en PVC effet bois, couleur naturel ou noyer, un seul élément continu;
2. **NOVA CL** en bois massif divisé en secteurs.



Spindeltreppe mit runder Form erhältlich;

Stufen aus Buchenholz;

Zentralstange aus Metall;

Geländer mit lackierten Stahlsäulen;

Geländer:

1. **NOVA** aus PVC in Holzoptik, Natur oder Nussbaumfarben, ein einziges durchgehendes Element;
2. **NOVA CL** aus Massivholz, unterteilt in Sektoren.



Escalera de caracol disponible con forma redonda;

Escalones de madera de haya;

Poste central en metal;

Barandilla con columnas de acero pintado;

Barandilla:

1. **NOVA** en PVC efecto madera, color natural o nogal, un único elemento continuo;
2. **NOVA CL** fabricado en madera maciza dividida en sectores.

NOVA

Dettagli tecnici

Technical details - Détails techniques
Technische Details - Ficha técnica

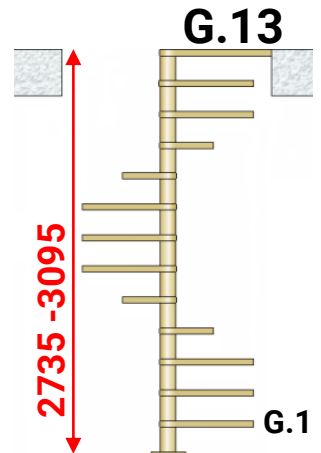
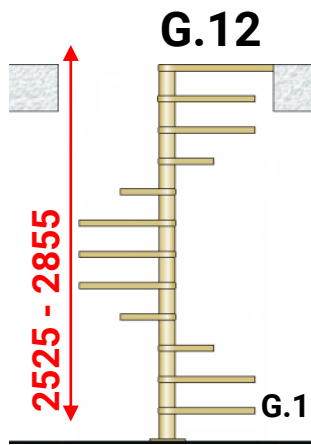
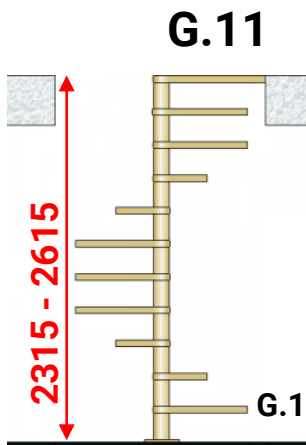

IMBALLO
Dim. 115x97x74 cm
Peso: circa 190/250 kg.

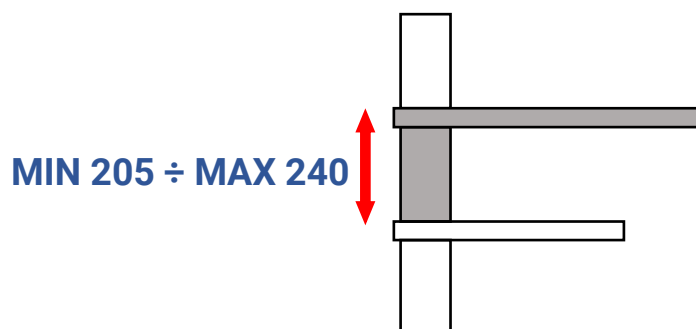
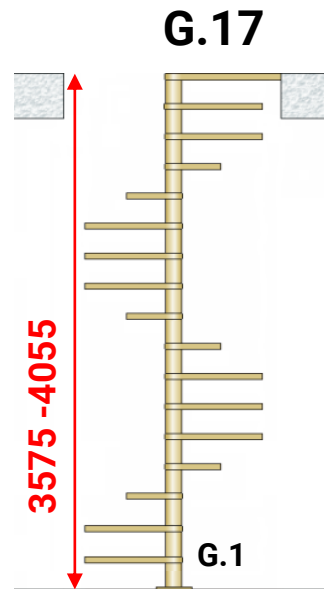
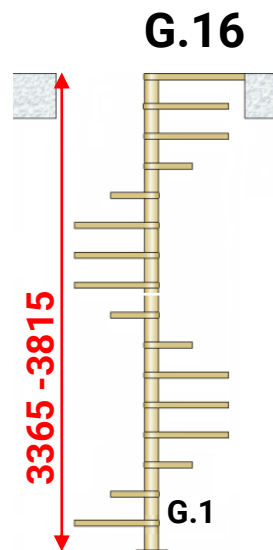
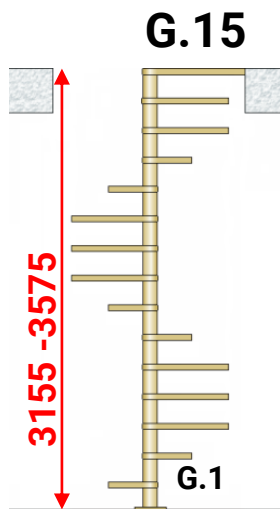
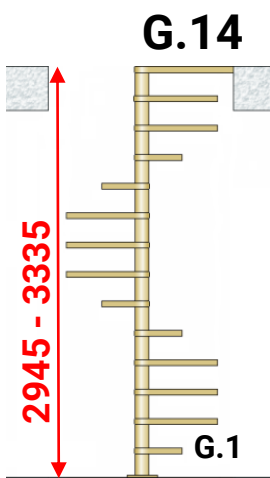

NOVA

Dettagli tecnici Technical details - Détails techniques Technische Details - Ficha técnica

L	C1	C3	P.U.	P.M.
Ø1200	675	649	480	157,9
Ø1400	773	743	580	165,7
Ø1600	873	838	680	189,1

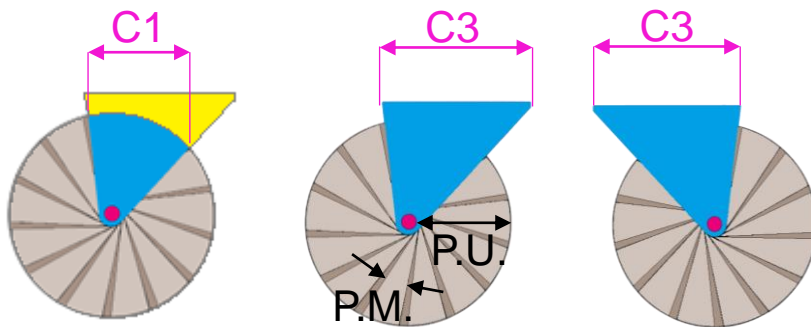

FORO, WELL, TRÉMIE, LOCH, HUECO

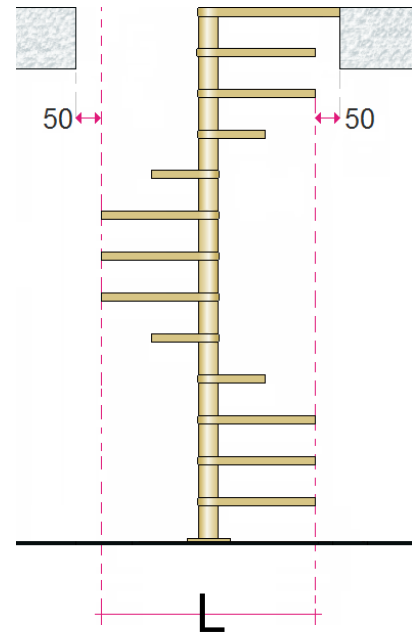

FISSAGGIO ARRIVO SBARCO, FIXING OF THE ARRIVAL LANDING,
FIXATION DU PALIER D'ARRIVÉE, BEFESTIGUNG DES ANKUNFTSPODESTS

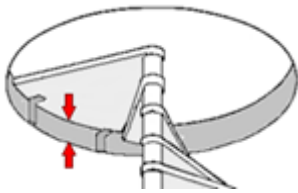

MIN 210

LEGNO, WOOD, BOIS, HOLZ, MADERA

APERTURA GRADINI, TREADS OPENING, OUVERTURE DES MARCHES,
ÖFFNUNG DER STUFEN, APERTURA DE LOS ESCALONES

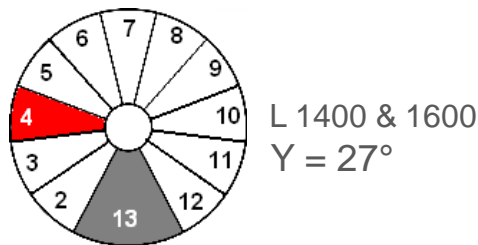
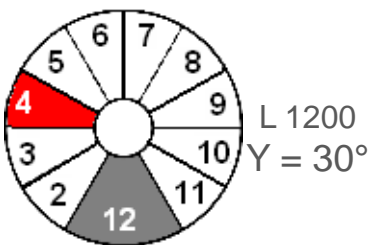

Faggio
Beech
Hêtre
Buche
Haya

NOVA

NOVA T

Ø45 PVC effetto legno
PVC wood effect
PVC effet bois
PVC-Holzoptik
PVC efecto madera

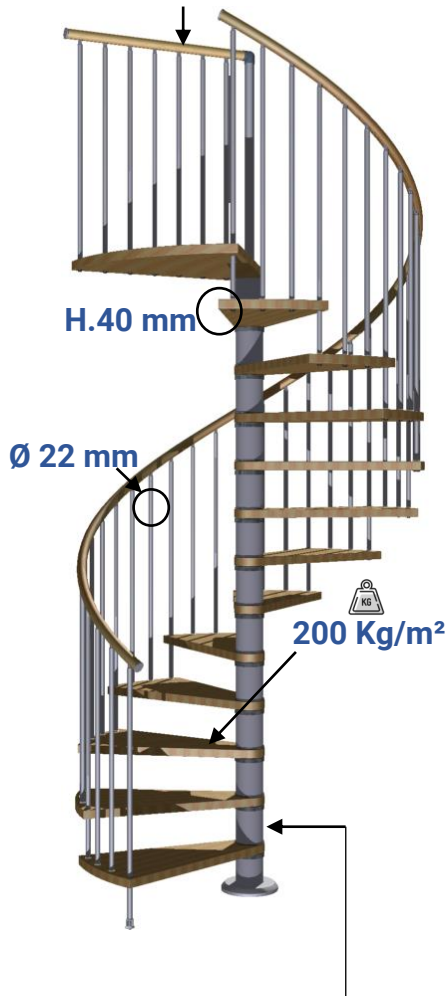

Metallo o legno – Ø127
Metal or wood - Métal ou bois
Metall oder Holz - Metal o madera

NOVA CL

Ø45 Legno
Wood
Bois
Holz
Madera

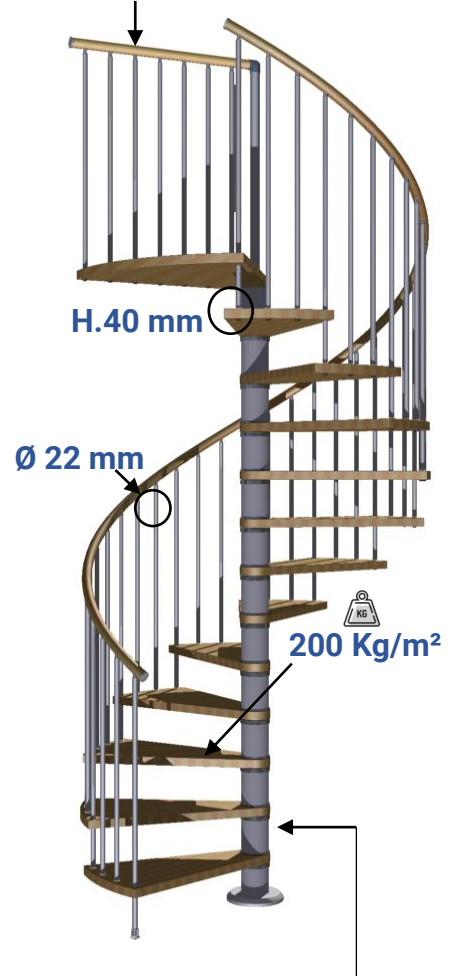

Metallo o legno – Ø127
Metal or wood - Métal ou bois
Metall oder Holz - Metal o madera

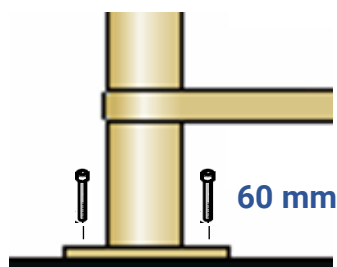

NOVA

Balaustra

Balustrade – Balustrade

Balustrade - Balaustrada

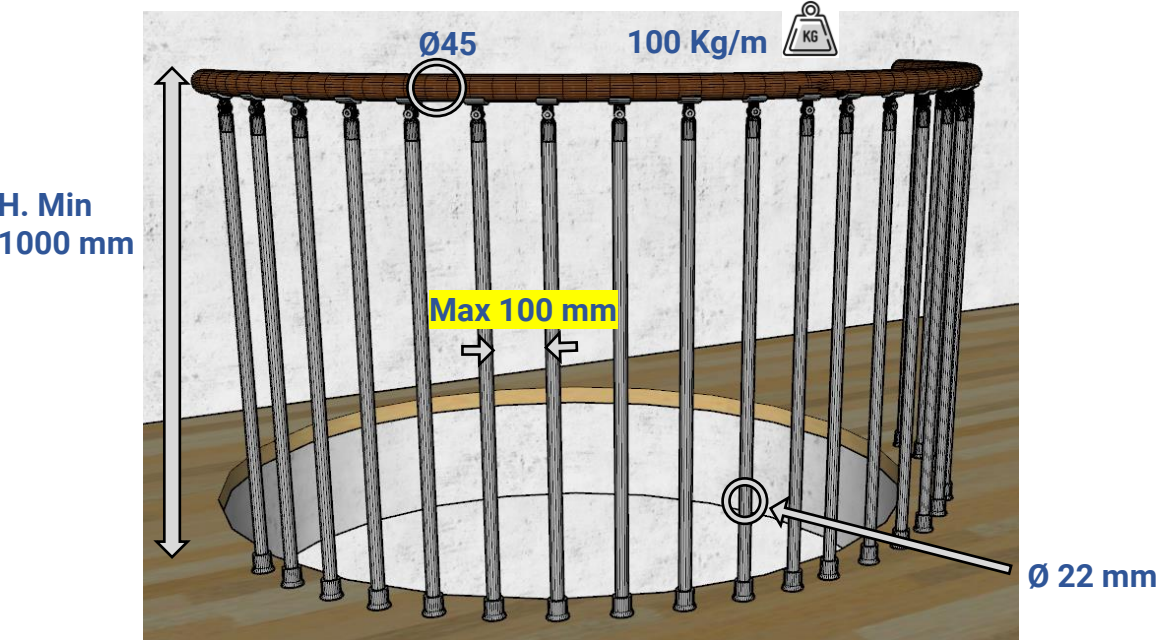
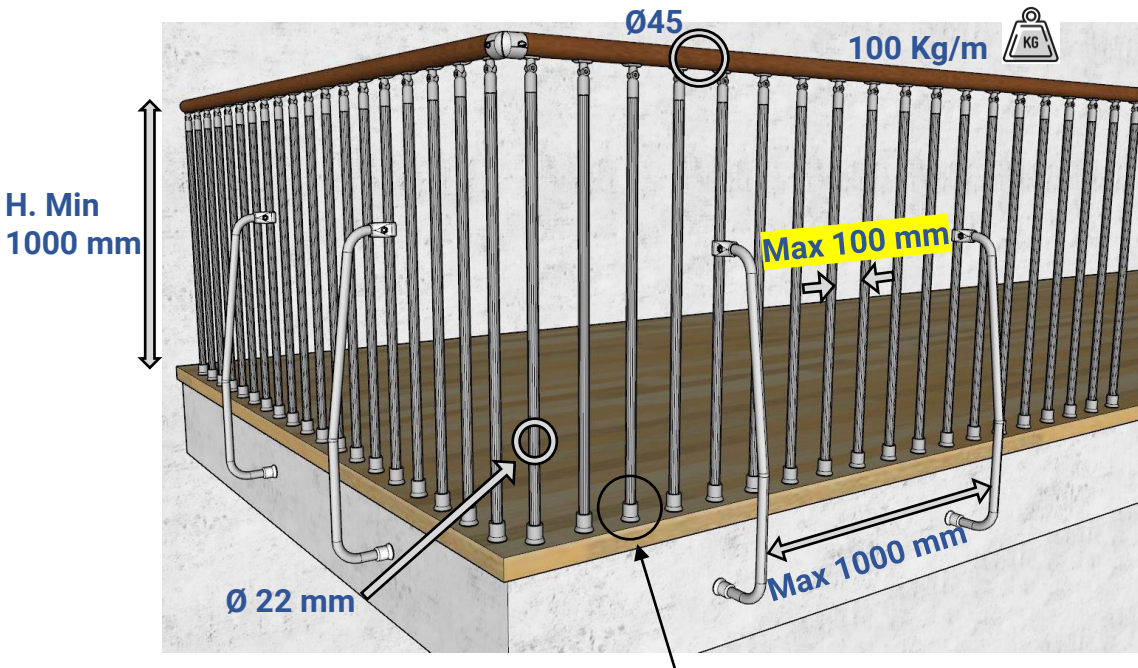

60 mm

CORRIMANI - Handrails - Mains courantes – Handläufe - Barandillas



NOCE
CHESTNUT
NOYER



NATURALE
NATURAL
NATURELLE



Ø45 PVC effetto legno
PVC wood effect
PVC effet bois
PVC-Holzoptik
PVC efecto madera

Ø45 Legno
Wood
Bois
Holz
Madera

NOVA

Legno

Wood - Bois
Holz - Madera



253 Naturale
Natural
Naturbuchenholz
Couleur naturelle
Natural



252 Noce medio
Light chestnut
Noyer moyen
Nussbaumholz
Nogal medio

Metallo

Metal
Métal
Metall
Metal

Componenti termoplastici

Thermoplastic components
Composants thermoplastiques
Thermoplastische Bauteile

Componentes termoplásticos



90 RG

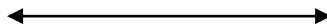

97 RG

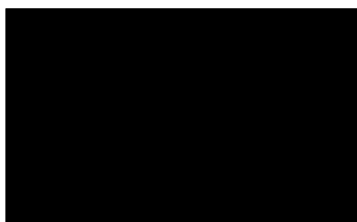

95 RG

