

# VOGUE

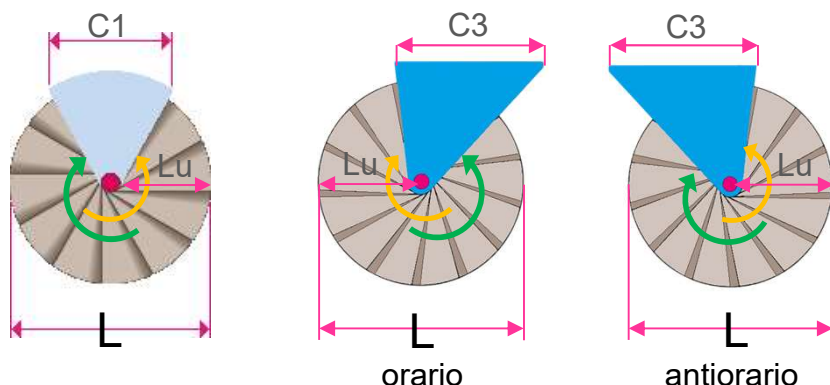

# VOGUE

DIAMETRI E PIANEROTTOLI, DIAMETERS AND LANDINGS, DIAMÈTRES ET PALIERS



Diametri disponibili, senso di salita, forme e possibili pianerottoli d'arrivo con dimensione d'uscita per scale a pianta circolare.  
Lu indica il passaggio utile sulla scala.

Available diameters, staircase rotation, shapes and possible arrival landings with exit dimension for round.  
Lu indicates the useful step on the scale.

Diamètres disponibles, sens de rotation, formes et possibles paliers d'arrivée avec dimension de sortie pour escaliers ronds.  
Lu indique le passage utile sur l'échelle.

FORO, WELL, TRÉMIE

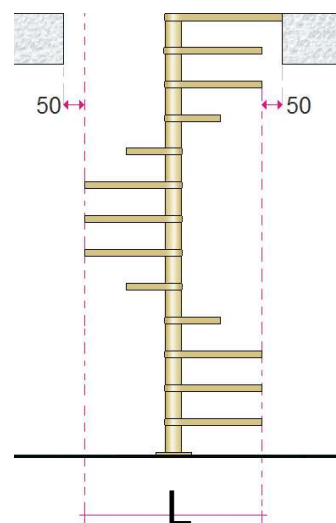

Ø L	C1	C3	Lu
1200	675	649	480
1400	773	743	580
1600	873	838	680

APERTURA GRADINI, TREADS OPENING, OUVERTURE DES MARCHES

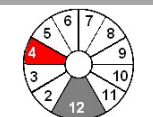

L 1200  
Y = 30°

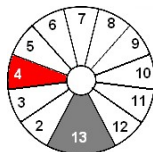

L 1400  
Y = 27°

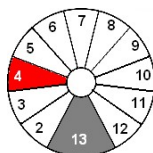

L 1600  
Y = 27°

FISSAGGIO ARRIVO SBARCO, FIXING OF THE ARRIVAL LANDING, FIXATION DU PALIER D'ARRIVÉE

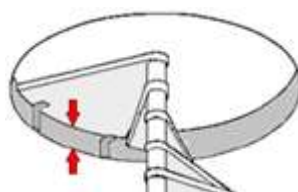

MIN 210

# VOGUE

ALTEZZE E NUMERO GRADINI, FLOOR HEIGHTS AND TREADS NUMBER, HAUTEURS ET NOMBRE DES MARCHES - G11 ÷ G...

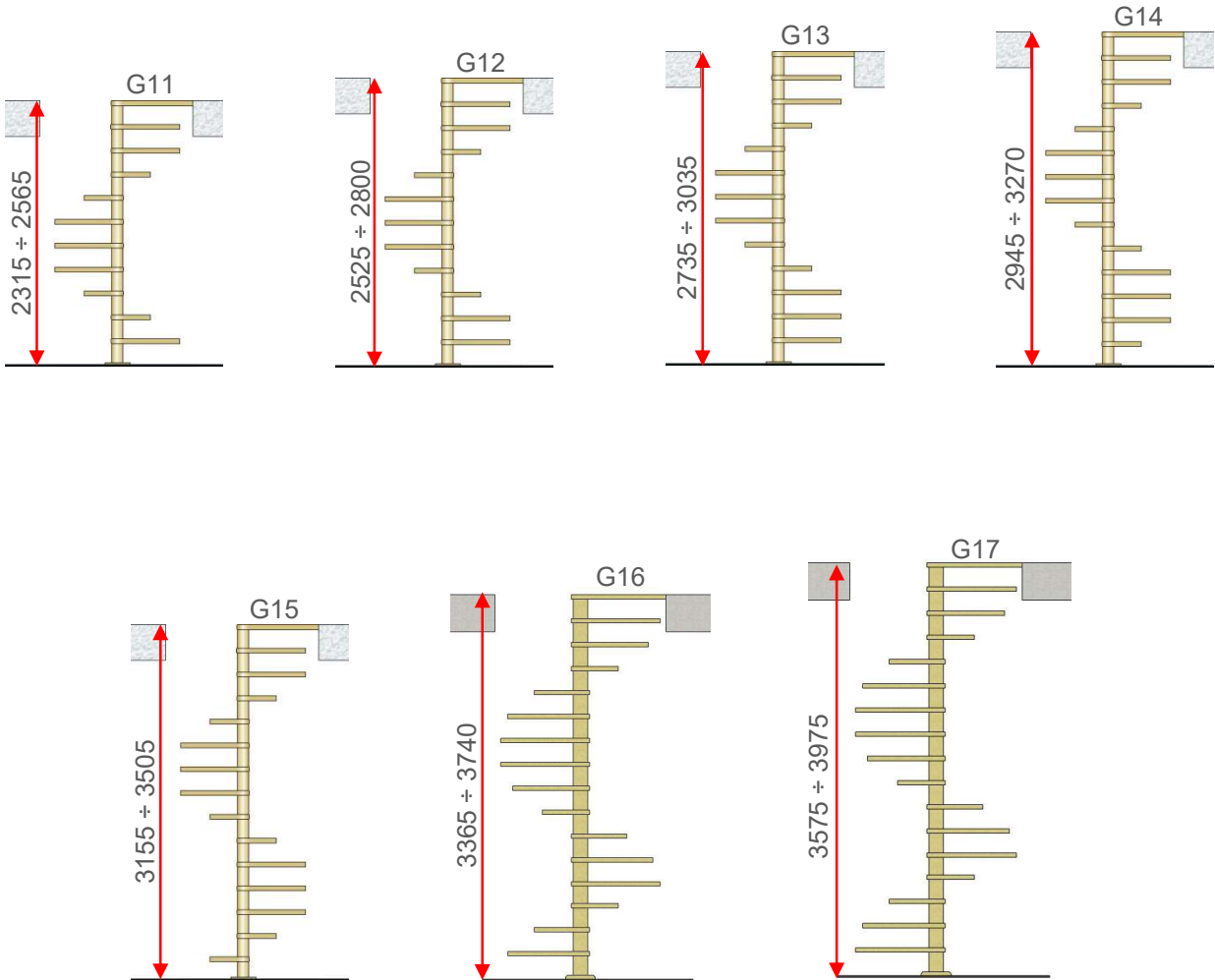

MIN 210 ÷ MAX 235

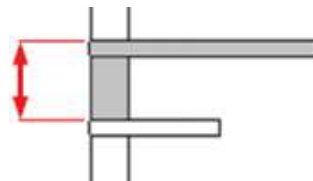

# VOGUE

CARATTERISTICHE, FEATURES, CARACTÉRISTIQUES

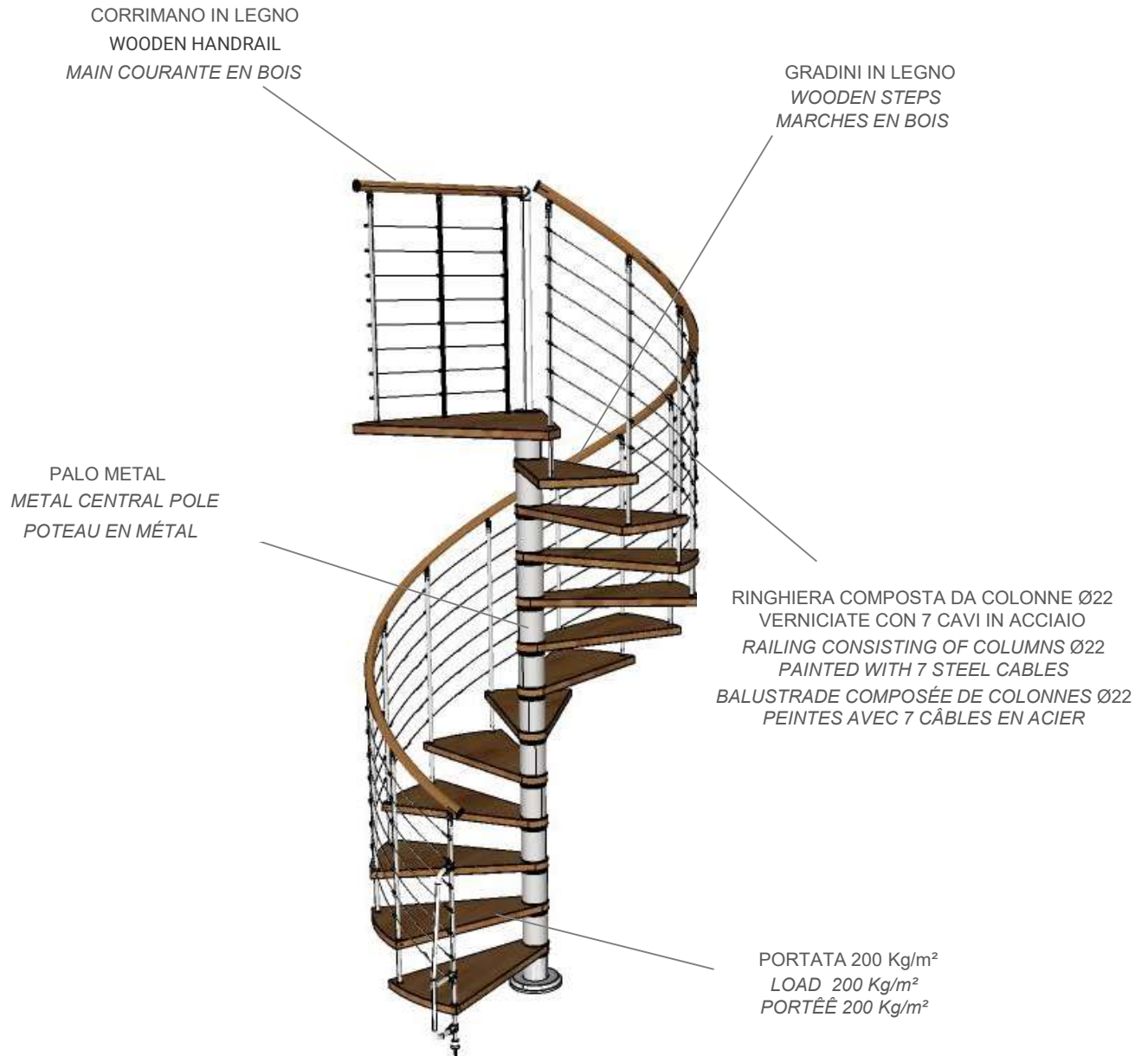

VOGUE

SENSO DI SALITA: ORARIO E ANTIORARIO  
USO INTERNO  
STAIRCASE ROTATION: CLOCKWISE AND ANTICLOCKWISE  
INTERNAL USE  
SENS DE MONTÉE: HORAIRE OU ANTI-HORAIRE  
USAGE INTÉRIEUR

**BALAUSTRÉ PROTEZIONE FORO, FLOOR PROTECTION BALUSTRADE, GARDE-CORPS ÉTAGE POUR LA TRÉMIE**

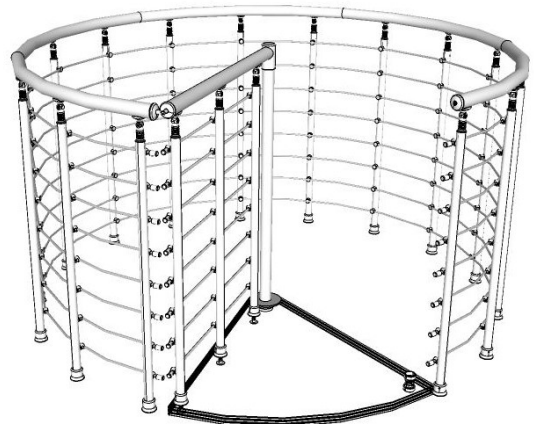
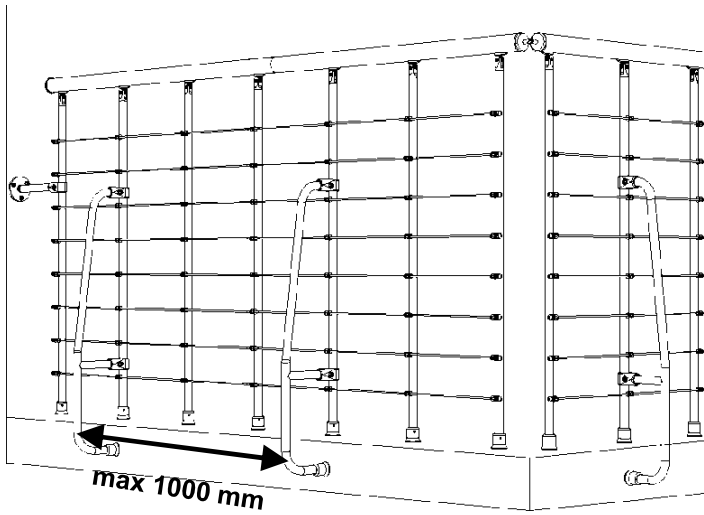
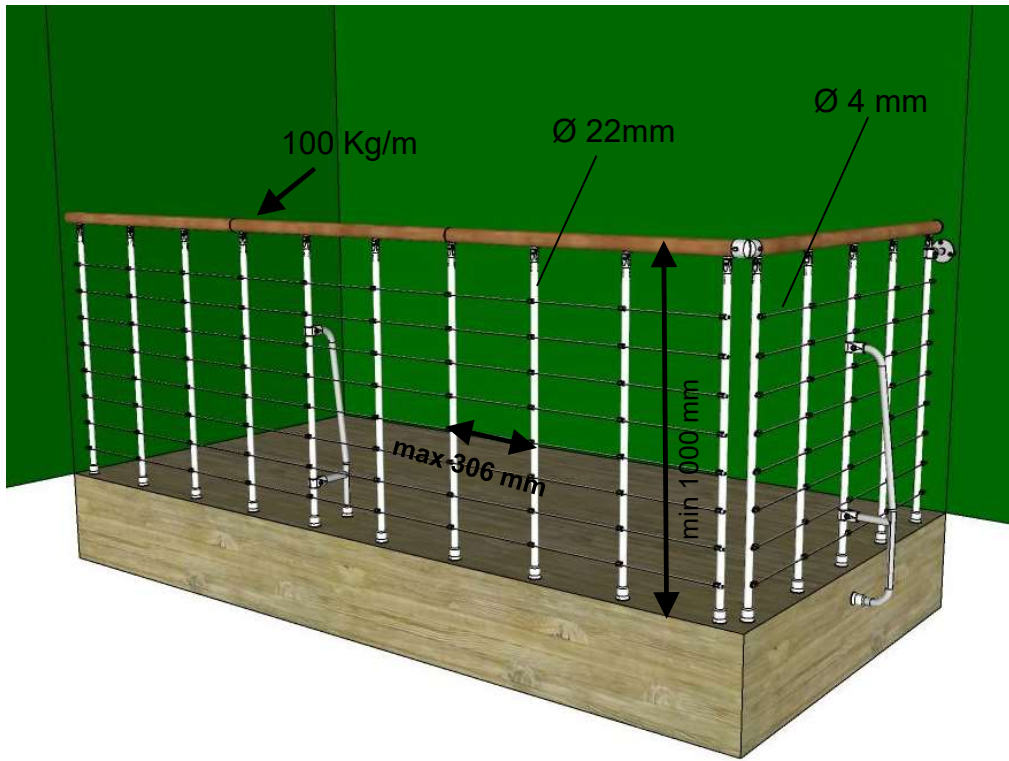

**CORRIMANO IN LEGNO – wood handrail- main courante en bois**